



California Tool & Die is a family owned business started in 1967. This year we are celebrating our 40th year in business serving the lighting industry. It has been 12 years since we introduced a new catalog, so this catalog is long time overdue. We hope that you will spend some time looking through it and will request samples of items you may be able to use.

All items shown are still made in the U.S.A. To accommodate the changing nature of the industry, we are adding more fabrication services and encourage you to bring us your custom requirements. Minimums are determined on a part by part basis.

We manufacture all of our own tooling and are currently looking for items to add to our line. We also build tooling for customer owned parts. Bring your prints and your ideas. We invite you to visit us and spend some time going through our sample room. We will provide you with a work area and assistance if you would like to come and play with our parts for your designs.

In addition to our stamping line, we also make a line of aluminum screenprinting frames. We purchased a business and moved it into our our shop in 2004; this has given us more fabricating capabilities including aluminum welding. This process is suitable for making aluminum outdoor lanterns. We would welcome your prints or samples to quote.

We look forward to the challenges ahead. We are currently in the process of improving our quality control program and In 2008 we will be pursuing ISO Compliance and Certification.

We thank each of you who have continued to support us with your business and look forward to growing that business. Challenge us and put us to work for you! Our combination of experience, flexibility, and technical expertise means you get an unsurpassed level of responsible management and corporate strength. When you put it all together you get the right products, the right service, and performance you can trust.

Please let us know if you would like an electronic version of this catalog.

See us on the web at www.californiatool-die.com and contact us by email at custserv.caltool@verizon.net.

TABLE OF CONTENTS

I.	Bobeches	1-24
	Examples of vent holes and prism holes on bobeches	2
	Regular bobeches	3
	Wrinkled and ribbed bobeches	4,5
	Petalled and floral bobeches	6,7
	Bobeches by size	8-24
II.	Bodies and Flat Caps	25-34
	Bodies, straight, listing	26
	Shaped bodies	27,28
	Stepped bodies	29
	Flat caps, listing	30
	Stepped caps	31
	Cover plates	32
	Square flat caps, specialty caps, furniture, & accessory caps	33
	Specialty caps	34
III.	Canopies	35-52
	Hole pattern samples, ordering options	36
	Flat canopies, listing	37
	Canopies by size	38-49
	Oval canopies	50
	Square canopies, wall back canopy	51
	Wall sconce, wall back	52
III.	Cups and Glassholders	53-72
	Straight cups, listing	54
	Straight pans, listing	55
	Socket cups	56,57
	Cups and Glassholders by size	58-68
	Embossed cups/glassholders	69-70
	Half balls, ball sets	71
	Neckless ballholders, bent glass glassholders	72
IV.	Filigree and Banding	73-80
	Standard bandings	74-78
	Line drawings of additional bandings, customer owned banding	79
	Samples of banded cups and holders	80
V.	Founts	81-94
	Fount listing	82,83
	Founts by size	84-94
VI.	Lamp Bases	95-112
	Hospitality bases, listing	96
	Flat bases, listing	97
	Candlestick bases	98
	Lamp bases by size	99-109
	Floor lamp bases	110,111
	Display stand bases	112
VII.	Leaves, Rosettes, & Related Parts	113-118
VIII.	Vase Caps	119-140
	Standard vase cap listing, turned in vase caps	120
	Vase caps by size	121-139
	Vase caps used as founts	140
VIII.	Additional Parts	141-156
	Recessed lighting parts, custom washers	142
	Plates, washers	143
	Pre-plated washers, lock washers, specialty washers, color & ID chips	144
	Shades, shadeholders	145-147
	Track lites, down lites	148
	Ceiling collars, porch lamp, pin-up light	149
	Square, rectangular wall backs	150
	Switch plates, decorative bracket assembly	151
	Miscellaneous brackets	152
	Candle cups & caps, banded & spotwelded candle cups, accessory parts	153,154
	Samples of various hole patterns	155
	Samples of custom and customer owned parts	156
IX.	Index	157-168

B O B B E C H E S



REGULAR



ROLLED

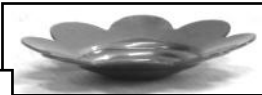

FLORAL



RIPPLED

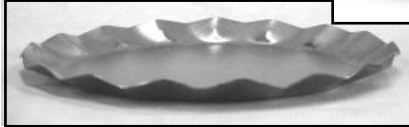
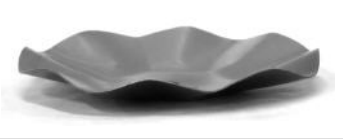

TURNED OVER EDGE

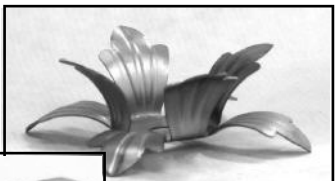

ROSETTES

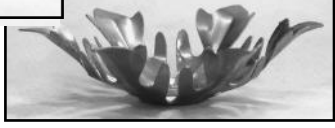

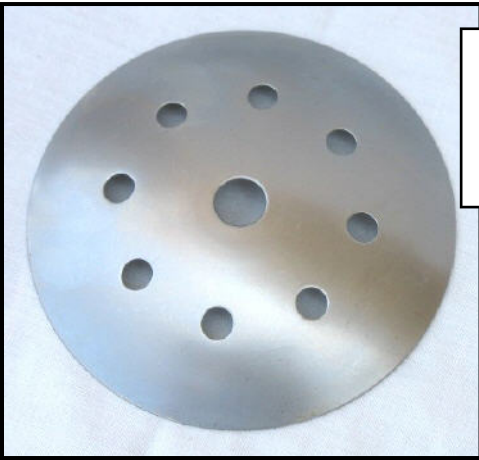

Vents available as standard option on 222 and 481 regular bobeches.
Want them on a different size, ask.

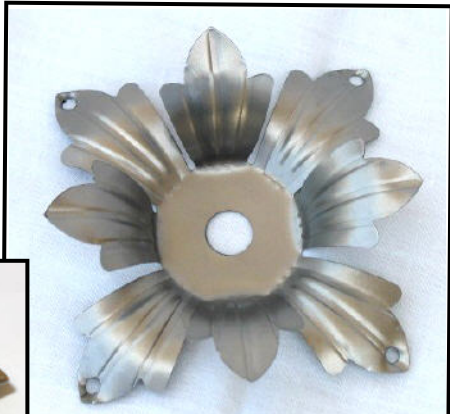

Prism holes currently available on A58, 5911, 5921, 5922 as a standard option.
Want prism holes on another bobeches, ask about availability.

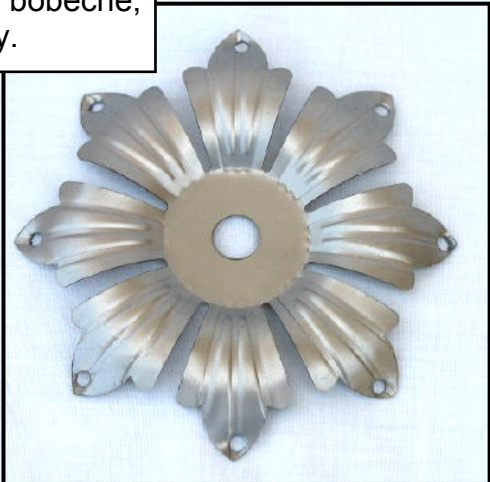
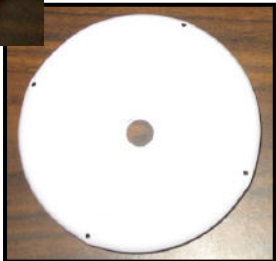

Custom variations are available by special order.

BOBECHES

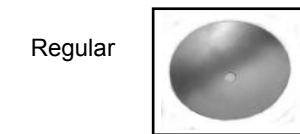
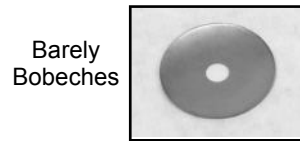
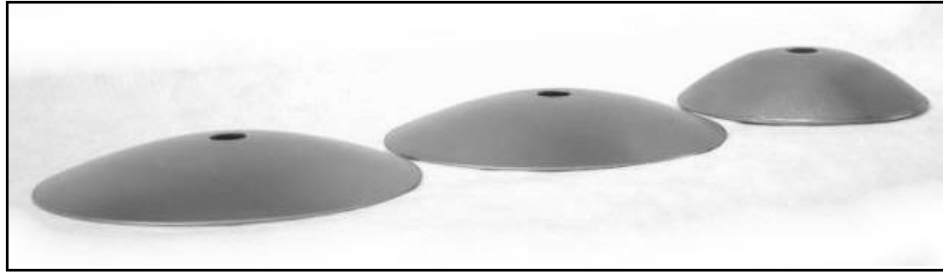

Part No.	OD	Height	Notes
281	2"	1/8"	
222	2 1/8"	7/16"	Available vented
322	2 1/2"	5/8"	
381	2 1/2"	5/32"	
410	3 1/16"	3/16"	
421	3 1/8"	3/8"	
422	3 1/8"	11/16"	
425	3 1/4"	3/16"	
481	3 7/16"	3/8"	Available vented
561	3 9/16"	7/16"	
5112	3 5/8"	5/8"	Standard w/ rolled edge
621	4 1/8"	1/2"	
6250	4 1/4"	1/2"	
620	4 1/2"	5/8"	
622	4 3/4"	7/16"	
705	5"	5/8"	
7052	5 1/8"	11/16"	Standard w/ rolled edge
7053	5 1/8"	1/2"	Standard w/roll edge & flat bottom
7142	5 1/8"	13/16"	Standard w/ rolled edge
7541	5 1/2"	1"	2" flat bottom
7545	5 1/2"	5/8"	
802	6 1/8"	1"	
1002-16	8 1/8"	1 5/16"	Standard 16ga-.524 center hole
1205-22	10"	1 13/16"	Standard 22ga-.625 center hole
1105-11	11"	1 3/4"	Standard 11ga-.531 center hole
1105D-11	11"	2"	Standard 11ga-.531 center hole

All sizes are approximate, for exact dimensions please call.

Part Variations-

- Part numbers 281-802 are standard with a .406 center hole to slip 1/8" pipe.
- All bobeches can be ordered with a 9/16" center hole or no center hole.
- Other size center holes are available upon request, (ie-3/16, 5/8, 3/4).
- Various gauges are available- specify gauge by adding the gauge number after the part number (ie- 281-20).
- Various metals (brass, copper, aluminum, stainless steel) can be ordered.

BOBECHES

WRINKLED and RIBBED BOBECHES



A33
2 5/16" OD
11/16" high



A35
2 9/16" OD
15/16" high

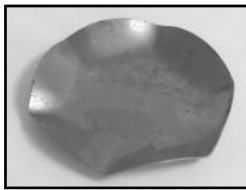
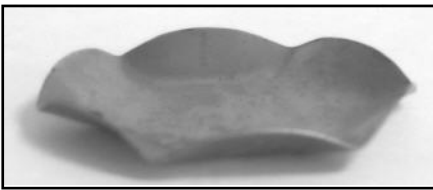

352
2 1/2" OD
5/16" high
Shown no center hole

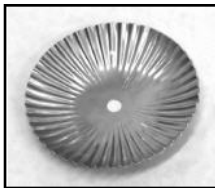
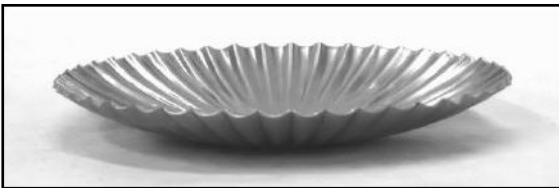

404-22
3" OD
3/16" high
Standard 22ga



460
3 1/2" OD
9/16" high

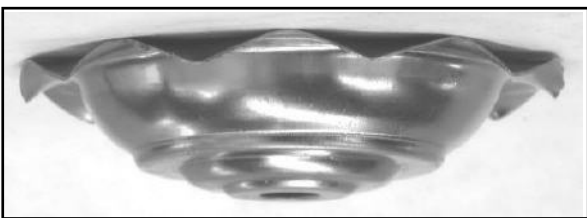

572
3 13/16" OD
2 7/8" ID
7/8" high

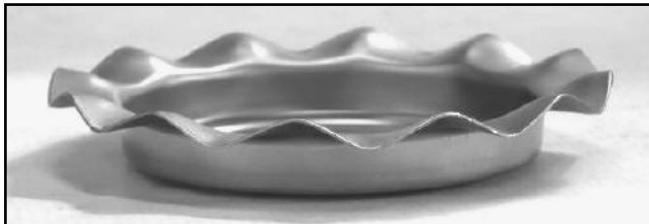



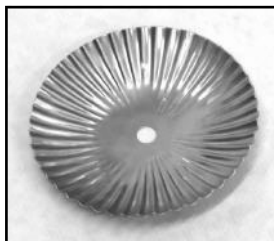
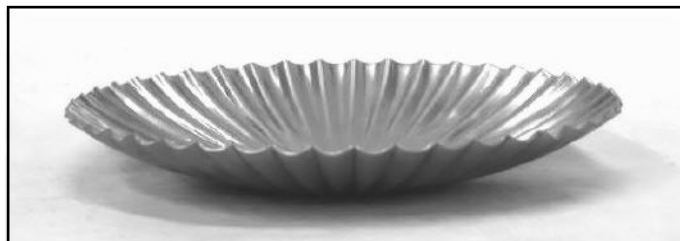

680
4 9/16" OD
3 7/16" ID
13/16" high

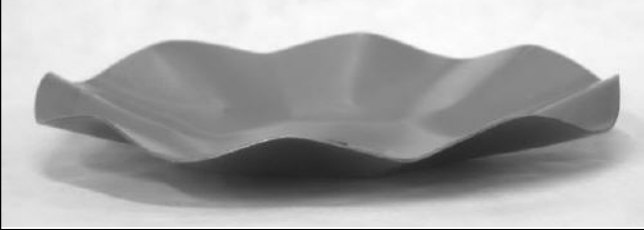

674-22
4 3/4" OD
5/8" high
Standard 22ga

BOBECHES

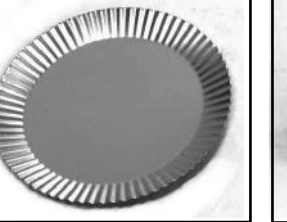
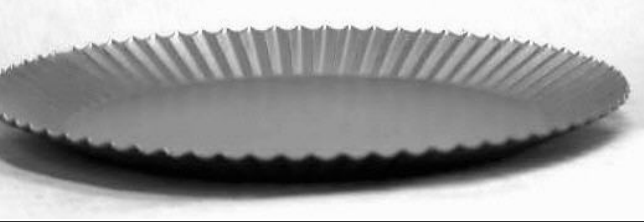
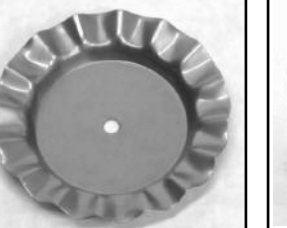
WRINKLED and RIBBED BOBECHES

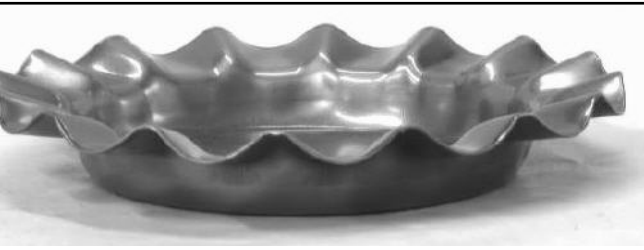
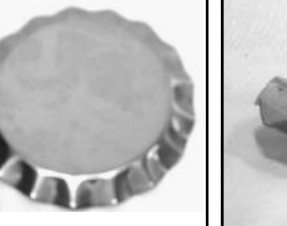
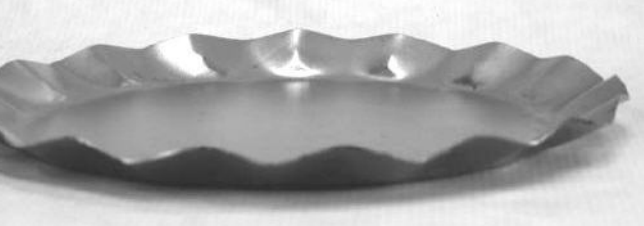
<p>D510 D610 4 5/8" OD 6 1/4" OD 1 1/4" high 1 3/4" high Available in various gauges</p>		
<p>7058-18 5 3/4" OD 5/8" high 1/2" flat flange Standard 18ga</p>		 <p>Shown powder coated white</p>
<p>6578 5 7/8" OD 4 1/2" ID flat 3/8" high Shown no center hole</p>		
<p>6515 6 1/4" OD 4" ID 11/16" high</p>		
<p>6515D 6 1/4" OD 4" ID flat 13/16" high Shown no center hole</p>		
<p>9515-22 7 11/16" OD 6" ID flat 1/2" high Standard 22ga Shown no center hole</p>		

***Bobeches are standard with .406 (1/8 IPS) center hole unless otherwise shown.
 All parts can be made with no center hole or a different size center hole.
 Parts are standard in 24ga CRS unless otherwise noted.
 Other metals or gauges available upon request.
 For custom variations, please call.***

PETALLED and FLORAL BOBECHES



Shown plated polished brass



5910
2 3/4" OD
2 5/8" ID
1 1/8" high



4001
2 13/16" OD
1 1/2" ID
1/4" high

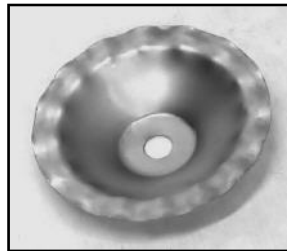
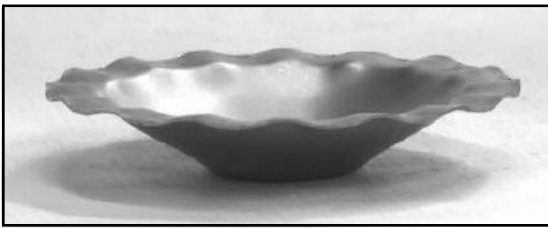

401
3 1/2" OD
11/16" high

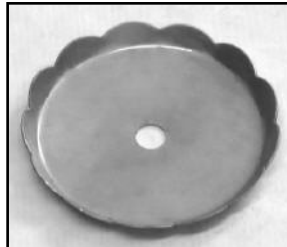
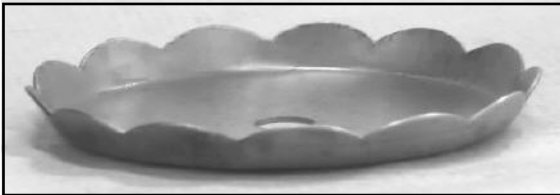

5400-20
3 1/2" OD
3" ID flat
5/16" high
Standard 20ga

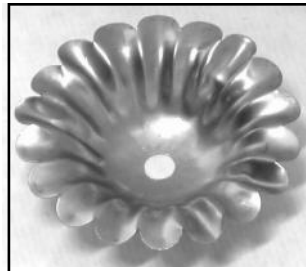

402
3 7/8" OD
15/16" high

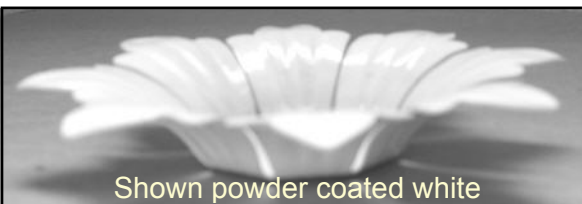

Shown powder coated white



5911
3 7/8" OD
1 1/4" ID
1/4" high

**Parts can be ordered with plated or powder coated finish.
For custom variations, please call.**

PETALLED AND FLORAL BOBECHES

5921
 3 7/8" OD 3/8" high
 Available with prism holes
 PN 5921-P
 Available 22ga PN 5921-22



5922
 3 7/8" OD
 1 1/4" ID
 1 1/16" high
 Available with prism
 holes PN 5922-P
 Available 22ga
 PN 5922-22

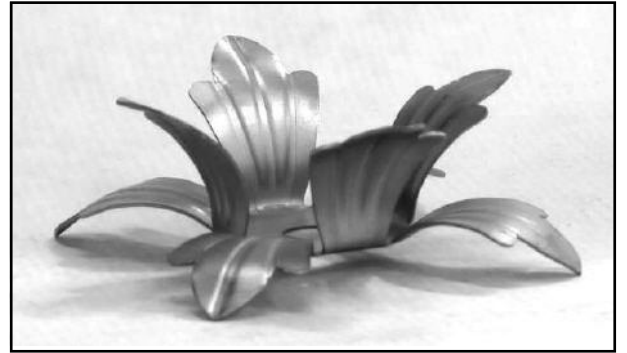
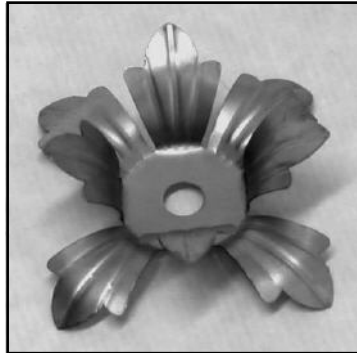

5622
 4" OD
 1" high

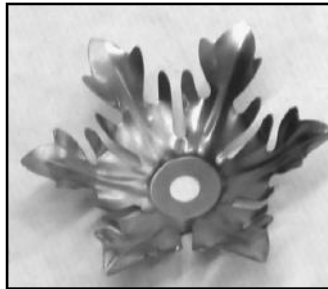

4021
 4 1/4" OD
 2" ID
 3/8" high

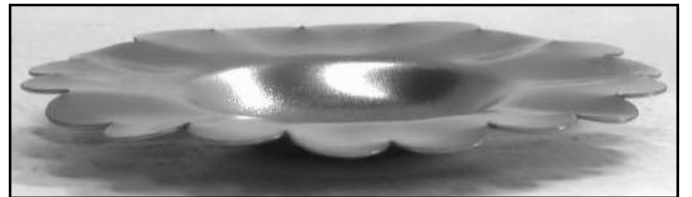
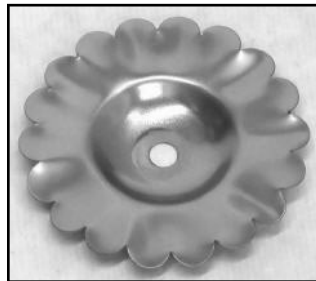

6421
 6" OD tip to tip
 1 1/2" high

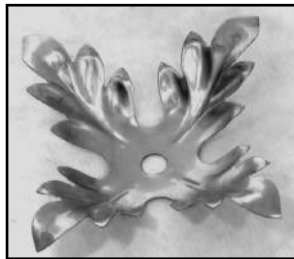

6422
 4 1/2" OD tip to tip
 3 1/8" petal to petal
 2 1/8" ID
 2" high

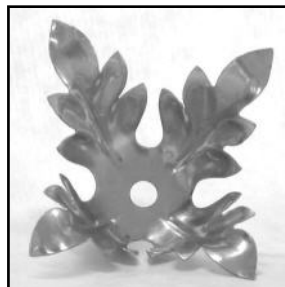

BOBECHEs



A11
1 9/16" OD
7/16" high

A21
1 13/16" OD
1/2" high



1811
2 1/16" OD
5/8" high

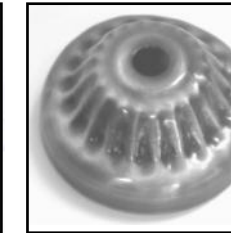

A33
2 5/16" OD
11/16" high



A31
2 3/8" OD
11/16" high

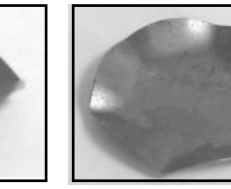
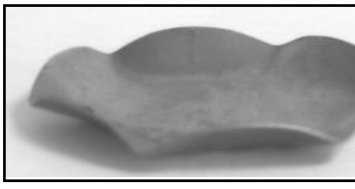

352
2 1/2" OD
5/16" high
Standard no center hole

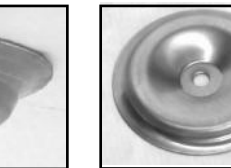
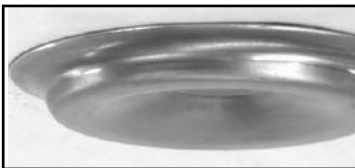

Q40
2 3/4" OD
1/4" high

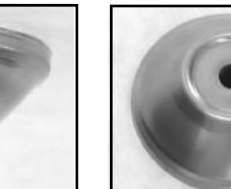

H40
2 3/4" OD
11/16" high

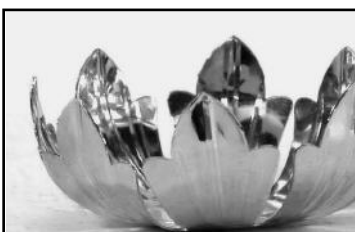

5910
2 3/4" OD
2 5/8" ID
1 1/8" high
Available with prism holes
PN 5910-P

Shown plated polished brass

*All parts are standard in 24ga CRS, unless otherwise noted.
Other metals and gauges are available upon request.
For custom variations, please call.*

BOBECHES

4001
 2 13/16" OD 1 1/2" ID
 1/4" high
 Available 20ga - PN 4001-20



440
 2 13/16" OD
 1 1/16" high



409
 2 15/16" OD
 1/4" high

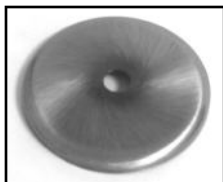

404-22
 3" OD
 3/16" high
 Standard 22ga

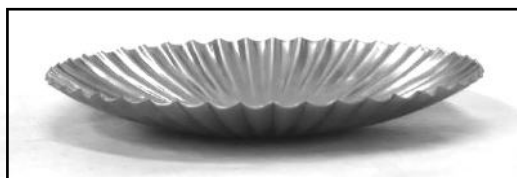

Q49
 3" OD
 1" high



Q478
 3 1/16" OD
 1 1/2" high
 Available 20ga
 PN Q478-20



468
 3 1/8" OD
 3/4" high



**Parts can be ordered with plated or powder coated finish.
 For custom variations, please call.**

BOBECHES



480
3 1/8" OD
3/4" high



483
3 1/8" OD
9/16" high



484 485
3 1/8" OD 3" OD
11/16" high 11/16" high



A44
3 3/16" OD
7/8" high



464
3 3/16" OD
3/4" high











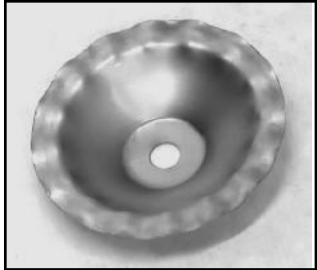
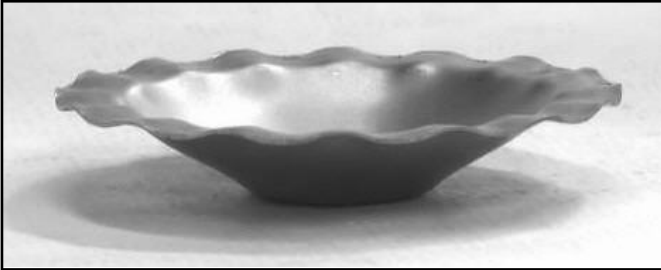

539
3 3/16" OD
15/16" high
Shown no center hole

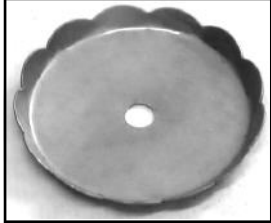
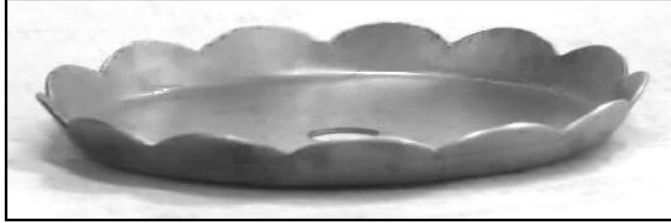

518 519
3 3/8" OD 3 7/16" OD
3/4" high 3/4" high

BOBECHES

<p>401 3 1/2" OD 11/16" high</p>		
<p>460 3 1/2" OD 9/16" high Available 22ga PN 460-22</p>		
<p>523 3 1/2" OD 7/8" high</p>		
<p>567 3 1/2" OD 5/8" high</p>		
<p>A58 3 1/2" OD 7/16" high</p>		
<p>5400-20 3 1/2" OD 3" ID flat 5/16" high Standard 20ga</p>		
<p>509 3 9/16" OD 3/8" high</p>		

BOBECHES



580
3 9/16" OD
1 1/16" high

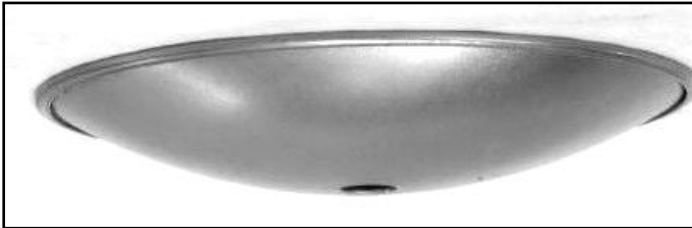

5112
3 5/8" OD
3/8" high
Standard with
rolled edge



A51
3 5/8" OD
1 3/16" high

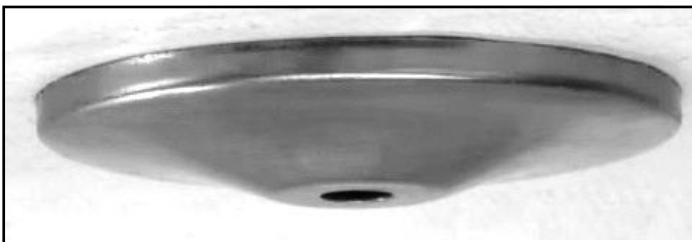

564
3 5/8" OD
7/8" high



568
3 5/8" OD
3/4" high



560
3 13/16" OD
1 1/8" high
Standard with
rolled edge

BOBECHES

572
 3 13/16" OD
 2 7/8" ID
 7/8" high

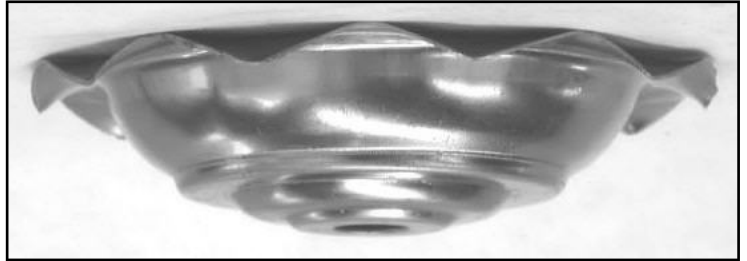

402
 3 7/8" OD
 15/16" high



5911
 3 7/8" OD
 1 1/4" ID
 1/4" high

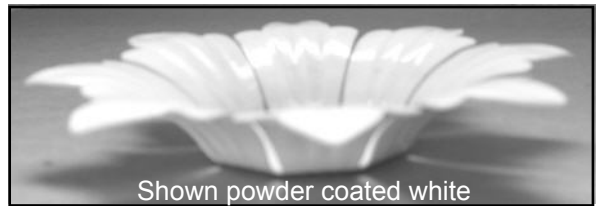
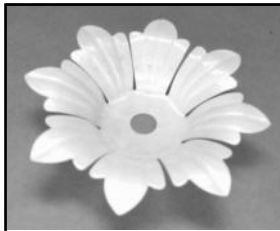

5921
 3 7/8" OD 3/8" high
 Available with prism
 holes PN 5921-P
 Available 22ga
 PN 5921-22



5922
 3 7/8" OD
 1 1/16" high
 Available with
 prism holes
 PN 5922-P
 Available 22ga
 PN 5922-22

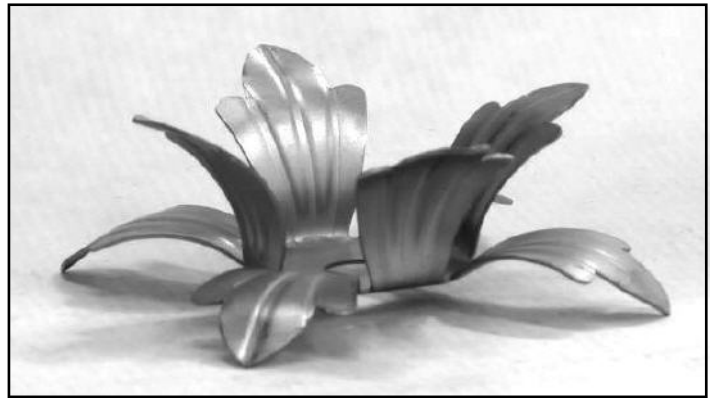

534
 3 15/16" OD
 3 1/2" ID
 1 1/8" high



BOBECHES

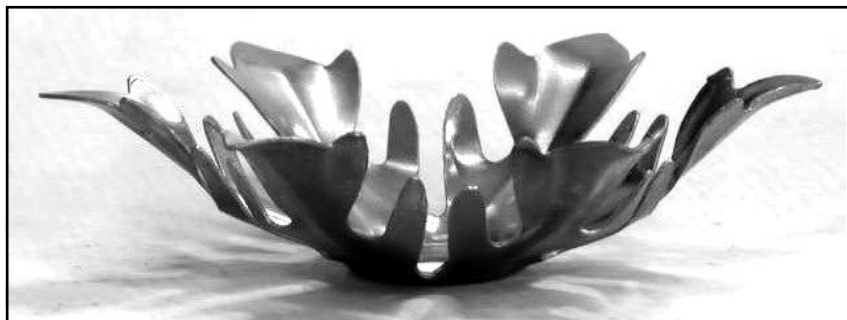

5622
4" OD 1" high

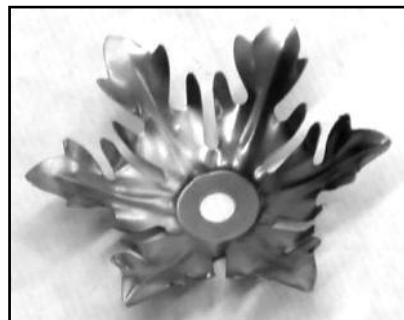

Q56
4 1/16" OD 1" high
Available 20ga PN Q56-20



625
4 1/16" OD 5/16" high



628
4 1/8" OD 1 3/16" high



BOBECHES



616
4 3/16" OD 3" ID
3/4" high

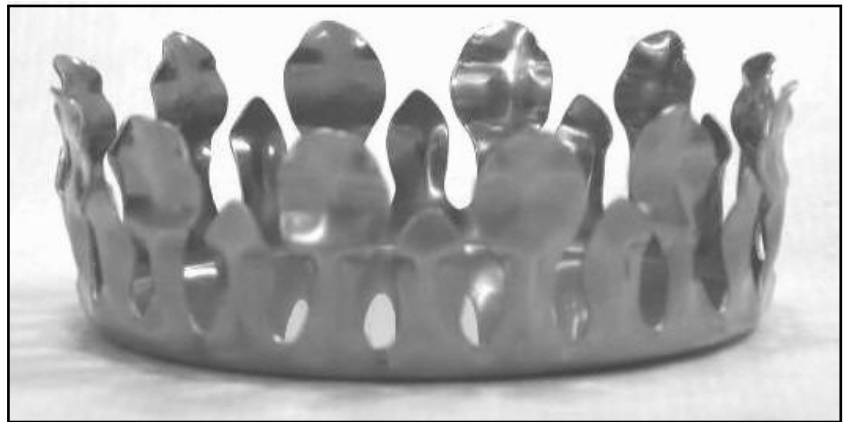
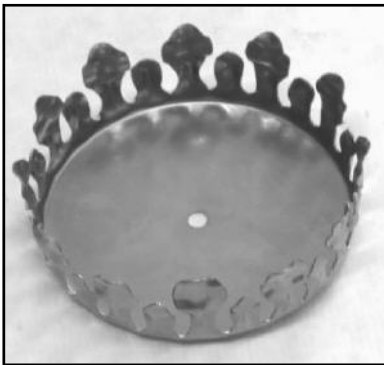

617
4 1/4" OD 4" ID flat
1 3/8" high



6347
4 1/4" OD 3 5/8" ID
1 3/16" high

BOBECHES

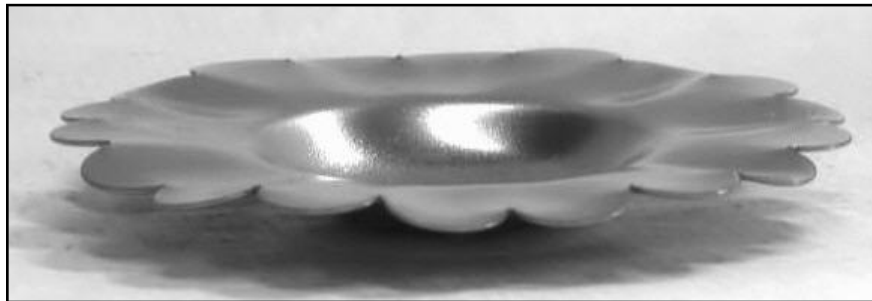

4021
4 1/4" OD 2" ID
3/8" high

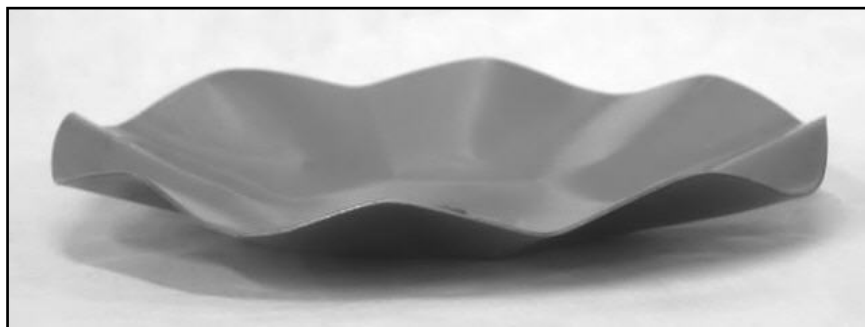

D510	D610
4 5/8" OD	6 1/4" OD
1 1/4" high	1 3/4" high
Available in various gauges	
Add gauge to part number (ie D510-18)	

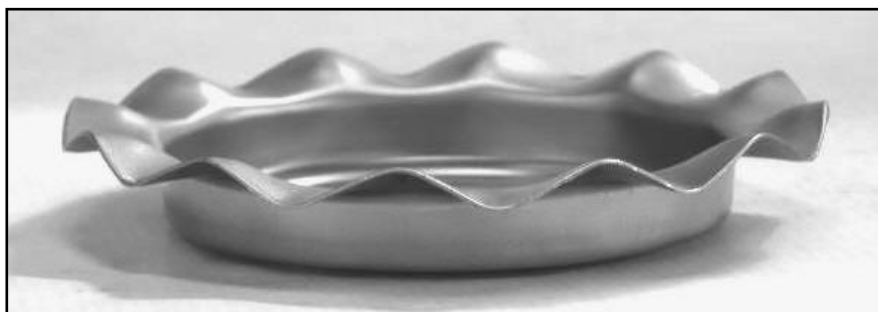

680
4 9/16" OD 3 7/16" ID
13/16" high



BOBECHES



681
4 3/4" OD 3 7/16" ID
9/16" high

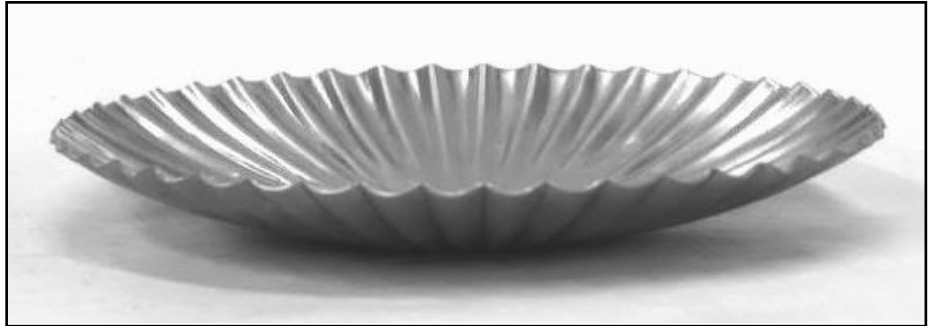
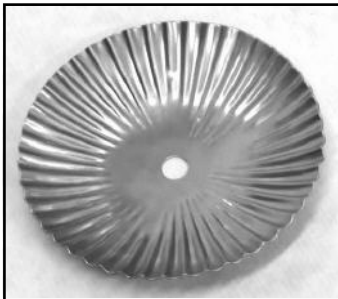

674-22
4 3/4" OD 5/8" high
Standard 22ga



759
4 7/8" OD 3/4" high

BOBECHES



709
4 7/8" OD 3 3/4" ID flat
1" high
Available 22ga PN 709-22



708-20
5" OD 1/2" high
Standard 20ga



718
5" OD 1 1/4" high
Available 20ga PN 718-20



BOBECHES

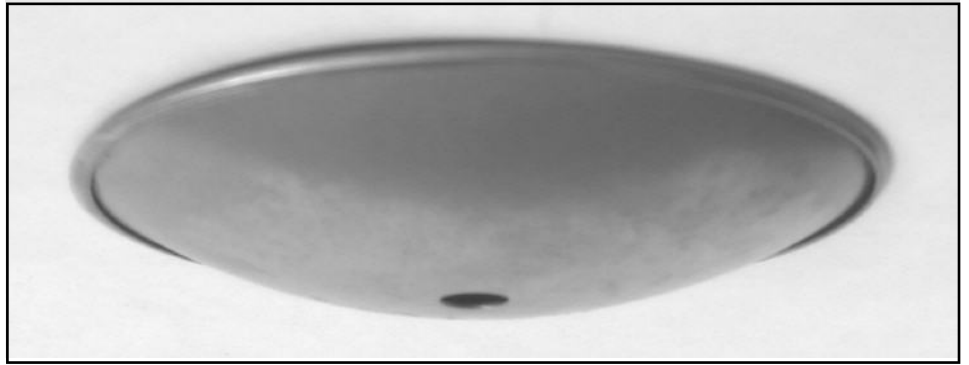
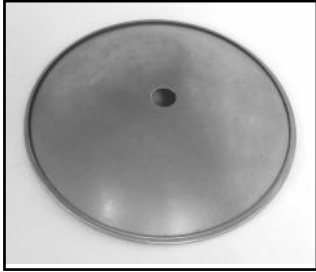

7052

5 1/8" OD 11/16" high
Standard with rolled edge
Available 22ga PN 7052-22

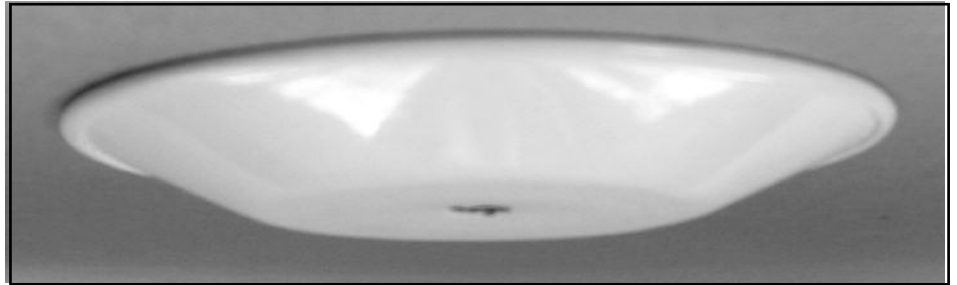
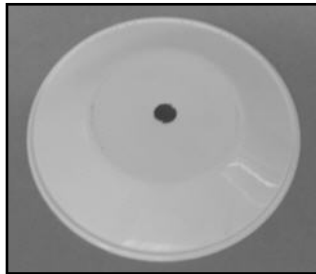

7053

5 1/8" OD 2 11/16" ID flat
1/2" high
Standard with rolled edge
Shown powder coated white

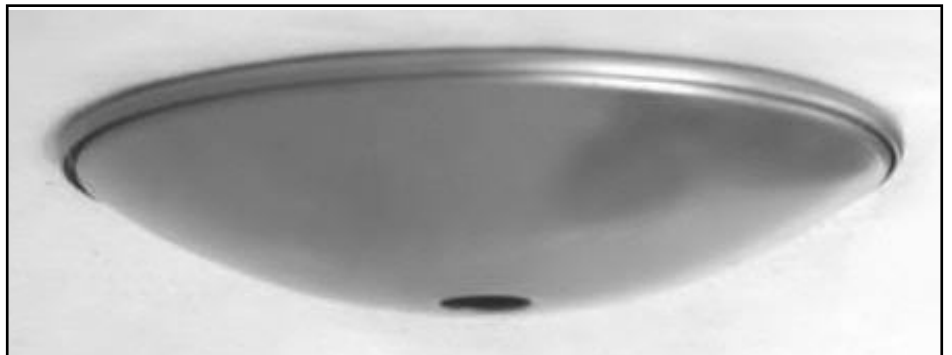

7142

5 1/8" OD 13/16" high
Standard with rolled edge

BOBECHES



716
5 1/4" OD 2 5/8" ID flat
7/8" high

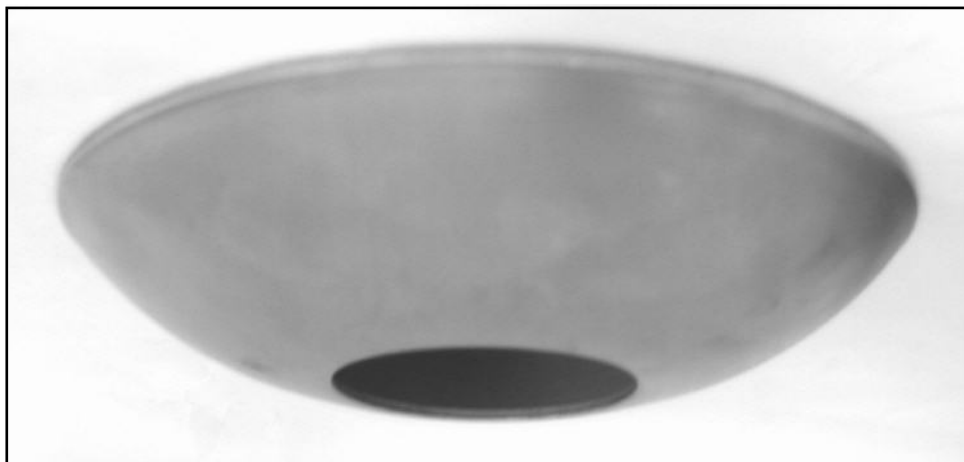

7541
5 1/2" OD 2" ID flat
1" high
Shown with 2" center hole



7058-18
5 3/4" OD 5/8" high
1/2" flat flange
Standard 18ga
Shown powder coated white

BOBECHES

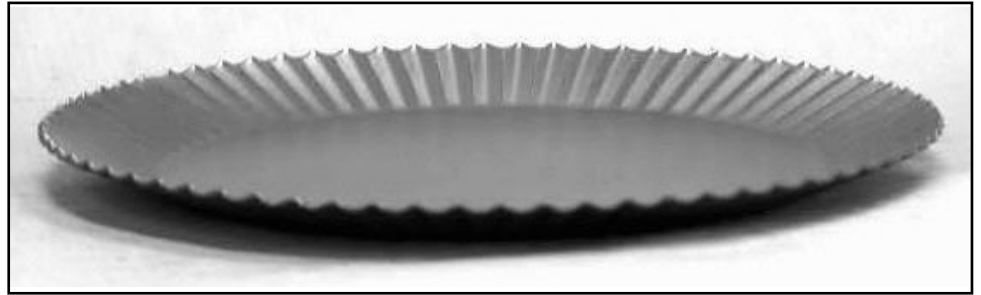
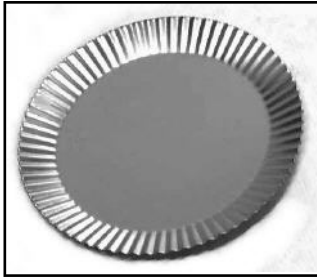

6578
5 7/8" OD 4 1/2" ID flat
3/8" high
Shown with no center hole



808-18
6 1/8" OD 5/8" high
Standard 18ga

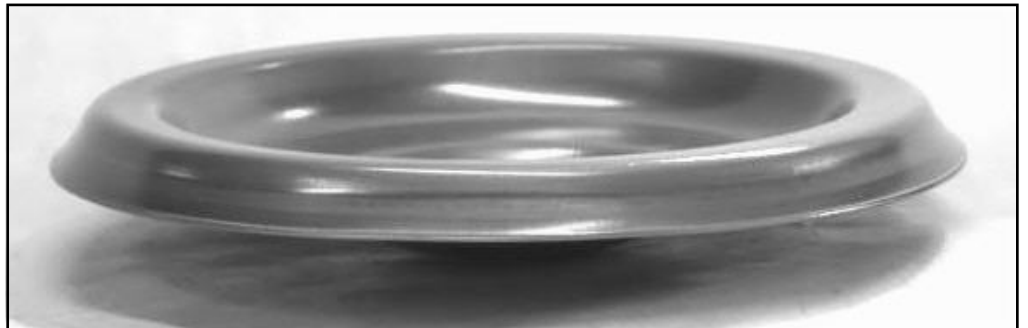

Q801-20
6 1/8" OD 15/16" high
Standard 20ga

BOBECHES

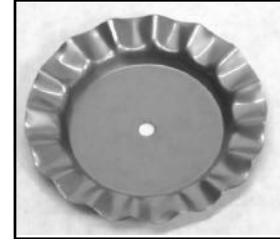

6515

6 1/4" OD 4" ID
11/16" high

6515D

6 1/4" OD 4" ID
13/16" high

Available in various gauges

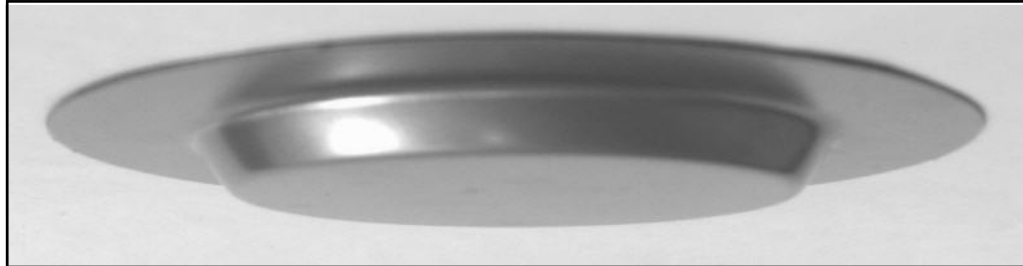

65151

6 3/8" OD 4" ID
1" uneven flat flange
3/8" high

Shown with no center hole

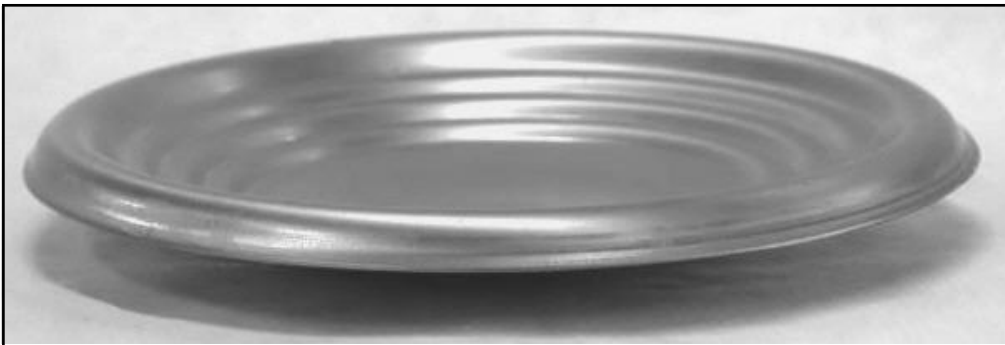

958-22

7 1/8" OD
1" high
Standard 22ga

BOBECHES

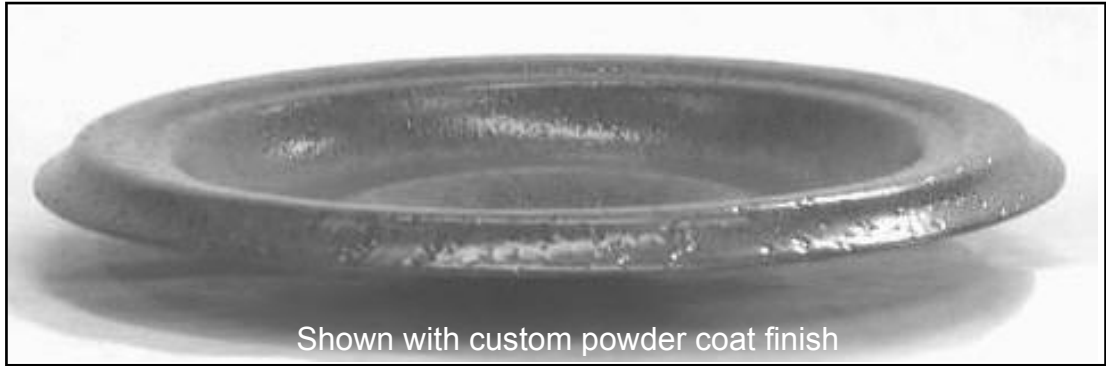

Shown with custom powder coat finish



959
7 1/4" OD
1" high
Standard 20ga

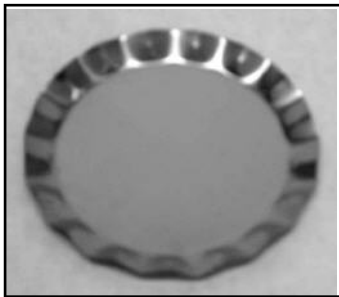
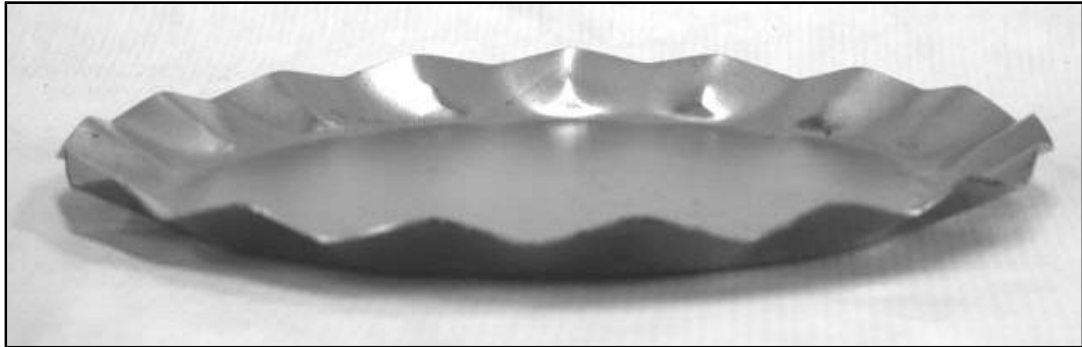

9515-22
7 11/16" OD
6" ID flat
1/2" high
Standard 22ga
Available in various gauges
Shown with no center hole

- All bobeches are standard in 24ga CRS, unless otherwise noted. Other metals and gauges available upon order.
- Most parts standard with .406 center hole. Parts can be made with no center hole or a custom size center hole.
- Parts can be ordered with a plated or powder coat finish.
- For custom variations, please call.

BOBECHES

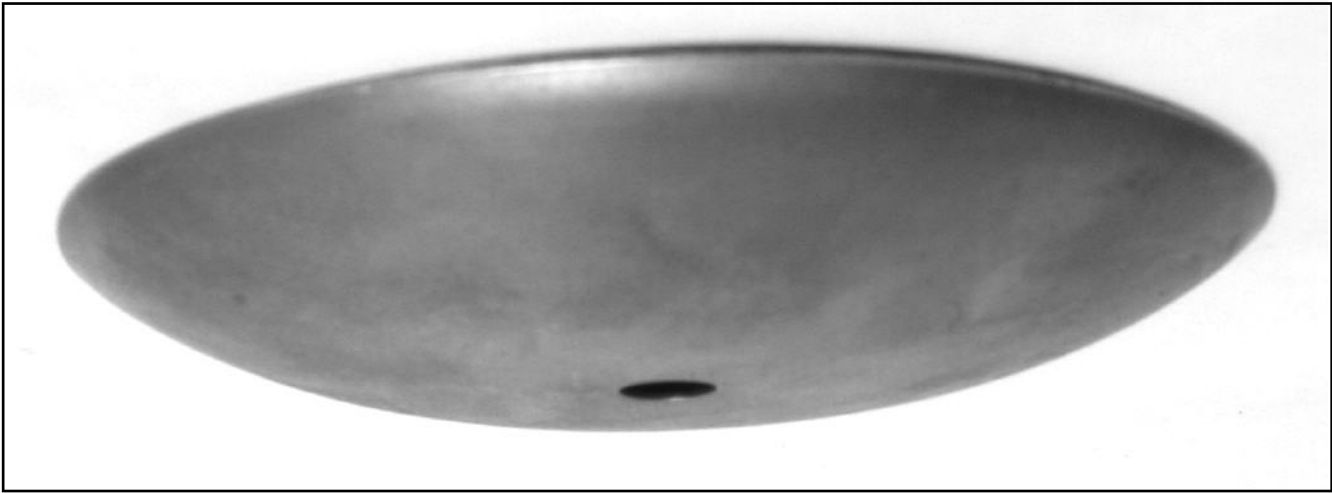

Part no.	OD	Height	Gauge & center hole size
802	6 1/8"	1"	Standard 22 & 20ga- .406 center hole
1002-16	8 1/8"	1 5/16"	Standard 16ga-.524 center hole
1205-22	10"	1 13/16"	Standard 22ga- .625" center hole
1105-11	11"	1 3/4"	Standard 11ga-.531 center hole
1105D-11	11"	2"	Standard 11ga-.531 center hole

NOTES:

DATE:

SAMPLES REQUESTED:

DATE SAMPLES RECEIVED:

PARTS ORDERED:



Fan bodies



Bottom holes



Side and custom holes



Stepped bodies



Custom caps



Stepped caps

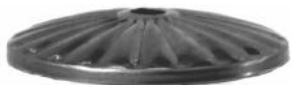

Embossed caps



**B
O
D
I
E
S**



**C
A
P
S**

BODIES



with bottom holes



with side holes

Bodies are standard in 18ga unless otherwise specified.

Part No.	OD	Height	Fits		Standard Variations
			Flat cap(s)	Vase cap(s)	
180	2"	1 3/16"	180C	181,1811,182	180-184-1845 Standard 24ga Available 20ga
184	2"	1 5/16"	180C	181,1811,182	
1845	2"	1 1/2"	180C	181,1811,182	
A3078	2 5/16"	7/8"	A30C,A36C	A31,320,364,3669	
A30	2 5/16"	1 1/4"	A30C,A36C	A31,320,364,3669	
330	2 5/16"	1 7/16"	A30C,A36C	A31,320,364,3669	
350	2 9/16"	1 1/8"	354		
A4658	2 3/4"	5/8"	A40C,A43C	A41,476,H476	
A4678	2 3/4"	7/8"	A40C,A43C	A41,476,H476	
A46	2 3/4"	1 1/8"	A40C,A43C	A41,476,H476	
A48-3/4	3"	3/4"	A48C,A45C	482,485,48511,490	
A48-1	3"	1"	A48C,A45C	482,485,48511,490	
A48-1 1/4	3"	1 1/4"	A48C,A45C	482,485,48511,490	
A48	3"	1 1/2"	A48C,A45C	482,485,48511,490	
414	3 1/8"	1 5/32"	A42C,416	A44,431,464	
51678	3 7/16"	7/8"	A55C,A57C	521,523,531,567,581	
516	3 7/16"	1 5/16"	A55C,A57C	521,523,531,567,581	
A50	3 9/16"	1 1/2"	A50C	A51,564,568	
A52S	3 9/16"	3/4"	A50C	A51,564,568	
A52	3 9/16"	1 1/4"	A50C	A51,564,568	
A69S	4"	9/16"	624,623	628,629	Available 22,16ga
A69-3/4	4"	3/4"	624,623	628,629	Available 22,16ga
A69	4"	1 1/4"	624,623	628,629	Available 22,16ga
A61	4 3/8"	1 1/4"	A60C,A65C	631	Available 16ga
A62	4 3/8"	1"	A60C,A65C	631	Available 22,20ga
A63	4 3/8"	15/16"	A60C,A65C	631	
A66S-18	4 3/8"	1/2"	A60C,A65C	631	
A66-18	4 3/8"	11/16"	A60C,A65C	631	
603-18	4 3/8"	1 1/2"	A60C,A65C	631	
650-.5	4 1/2"	1/2"	Deep cap 650C		
650-.75	4 1/2"	3/4"	Deep cap 650C		
650-.8	4 1/2"	.825"	Deep cap 650C		
650-1	4 1/2"	1"	Deep cap 650C		
650-1.125	4 1/2"	1.125"	Deep cap 650C		
7705	5 1/32"	1 1/2"			
772	5 1/8"	1"	A70C		
772-1 1/8	5 1/8"	1 1/8"	A70C		
772-1 3/8	5 1/8"	1 3/8"	A70C		
792	5 1/2"	1"	A79C		
7972	5 5/8"	1"			
807-18	6 1/8"	1 1/4"			

BODIES

A231
 1 3/4" OD 1 1/2" high
 Standard 22ga
 A20C, A23C, A21 fit A23



192
 2" OD 1 1/8" high
 Standard 20ga
 180C, 181, 1811, 182 fit 192



331
 2 5/16" OD 1 7/16" high
 Standard 18ga
 A30C, A36C, A31,
 320, 364, 3669 fit 331

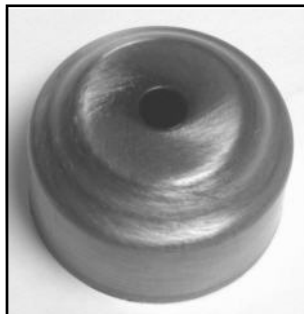

459
 3" OD 1 9/16" high
 A48C, 482, 485,
 48511, 490 fit 459



488
 3" OD 1 5/8" high
 A48C, 482, 485,
 48511, 490 fit 488



A53-22
 3 19/32" OD
 13/16" high
 Standard 22ga



BODIES



A68
 4 1/16" OD
 1 1/4" high
 628, 629, fit A68



648-18
 4 1/8" OD 15/16" high
 Standard 18 ga

Standard with 3/16" center hole
 Available with others

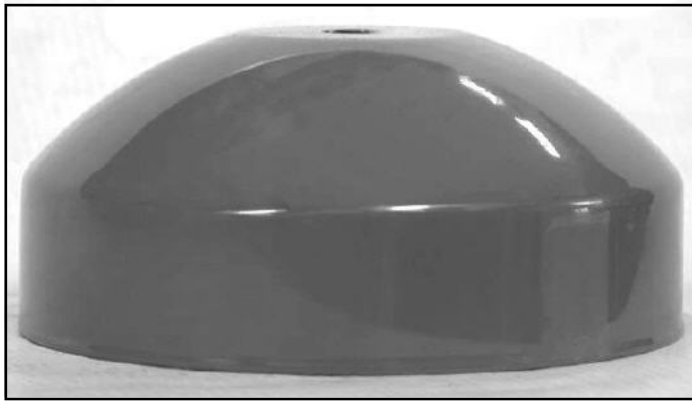

Shown with gloss powdercoat finish

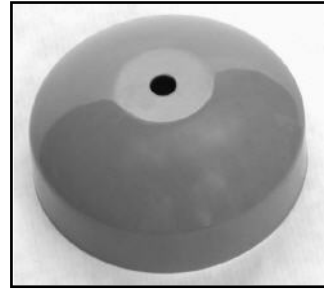

6454-20
 4 3/8" OD 1 15/16" high
 A60C, A65,C, 631 fit 6454-20

Standard 20ga



Shown with gloss laquer finish

8975
 6 9/16" OD 1 9/16" high
 Standard 18 ga



STEPPED BODIES

A37-18
 2 3/4" OD 1 3/16" high
 A30C, A36, A31, 320, 364,
 3669 fit A37-18



A47
 2 3/4" OD 1 7/32" high
 A40C, A43C, A41,
 476, H476 fit A47



FAN BODIES

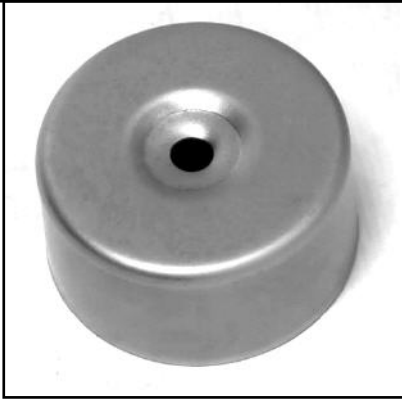

415
 3 1/8" OD 1 1/2" high

A42C, 416, A42C,
 431, 464 fit 415



515
 3 7/16" OD 1 1/2" high

A55C, A57C, 521, 523,
 531, 567, 581 fit 515



523-515-FAN-4SL-SSW



*Shown with fan holes on top &
 side holes & switch hole on side*

FLAT CAPS



PART NO.	ID	HEIGHT	FITS BODY/CUP#
A9C	1 5/16"	3/16"	
A10C	1 1/2"	3/16"	
A20C	1 3/4"	3/16"	A20, A23, A24
A20C-D	1 3/4"	5/16"	A20, A23, A24
180S	1 15/16"	1/4"	
180C	2"	3/16"	180 SERIES
180C-D	2"	5/16"	180 SERIES
200C	1 31/32"	1/4"	
A30C	2 5/16"	1/4"	A30, 301, 302, 330, 331
A30C-D	2 5/16"	5/16"	A30, 302, 302, 330, 331
350C	2 1/2"	3/16"	
A40C	2 13/16"	3/16"	A46 SERIES, INSIDE 458
A48C	3"	3/16"	A48 SERIES, 458, 459
A42C	3 1/8"	1/4"	414, 415
558C-I	3 3/32"	1/4"	INSIDE 558
510C	3 1/4"	1/4"	
510C-D	3 1/4"	3/8"	
51021	3 11/32"	3/8"	
A55C	3 7/16"	3/16"	515, 516
A55C-D	3 7/16"	5/16"	515, 516
A56C	3 1/2"		
A50C	3 9/16"	1/4"	A50 SERIES
575	3 3/4"	1/4"	
624	4 1/16"	1/4"	
A67	4 1/4"	3/8"	
A60C	4 3/8"	1/4"	A60 SERIES, 612
650C	4 1/2"	3/8"	
715	4 15/16"	9/32"	776
A70C	5 1/8"		772
754C	5 7/16"	1/4"	
A79C	5 1/2"		792
801C	6"	3/16"	
801S	6 1/16"	3/8"	

CAPS ARE STANDARD IN 24GA CRS
 ALL ARE STANDARD WITH A .406 CENTER HOLE (TO SLIP 1/8 PIPE)
 CAPS ARE AVAILABLE WITH BOTH STANDARD AND CUSTOM VARIATIONS
 SOME STANDARD VARIATIONS ARE AS FOLLOWS:
 -9 FOR 9/16" CENTER HOLE
 -NCH FOR NO CENTER HOLE
 -BU FOR RAW BRASS
 -(INSERT NUMBER)BL FOR BOTTOM HOLES
 (ie 3BL has center hole and 3 evenly spaced holes)

**CUSTOM VARIATIONS - MATERIAL TYPE, GAUGE, HOLE PATTERNS
 AND FINISH - ARE AVAILABLE BY SPECIAL ORDER.**

STEPPED CAPS



Stepped cap with stepped body
A36-A37
A43C-A47

A36
2 5/16" ID
5/16" high
1 13/32" across flat
Fits A30 series



354
2 5/8" ID
3/8" high
2 1/8" across flat
Fits 350 body



A43C
2 13/16" ID
5/16" high
1 5/16" across flat
Fits A46 series



623
4 1/16" ID
3/8" high
1 5/8" across flat
Fits A69



EMBOSSED CAPS



<p>A45C 3" ID 7/16" high Fits A48 series</p>	<p>416 3 1/8" ID 1/2" high Fits 414, 415</p>	<p>A65C 4 3/8" ID 1/2" high Fits A60 series</p>
---	---	--

Some variation in embossed design, ask for samples.

COVER PLATES

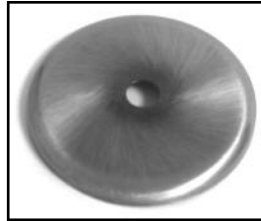
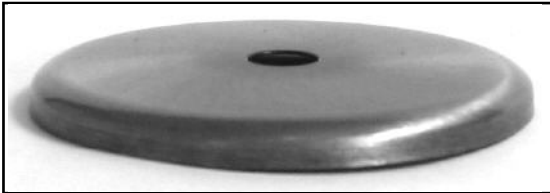

409
2 7/8" ID
1/4" high



509
3 1/2" ID
5/16" high
1-3/4" flat

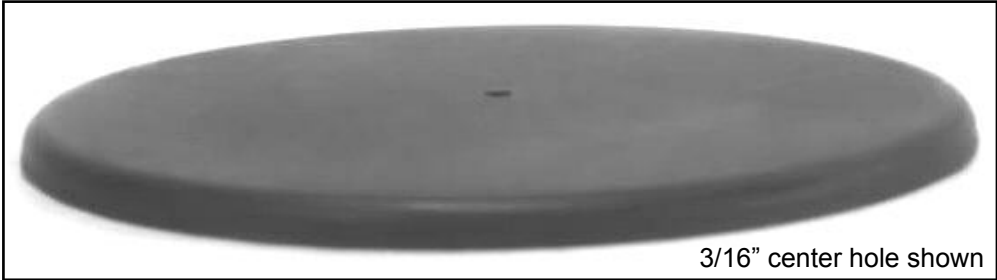

3/16" center hole shown

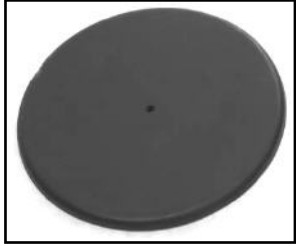

775	775-7	875	875-7
4 15/16" ID	4 15/16" ID	6" ID	6" ID
1/4" high	1/4" high	1/4" high	1/4" high
3/16" center hole	7/16" center hole	3/16" center hole	7/16" center hole

Standard in 20ga
7756-16ga and 7758-18ga are also available, with 7/16" center hole

**Heavy Gauge
Flat Caps**



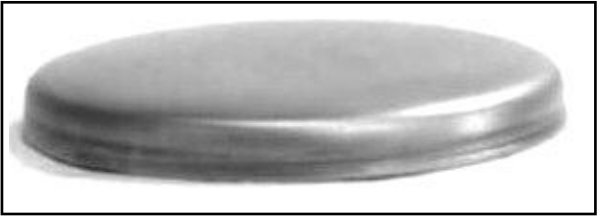

125-NCH-16	1 1/4" ID	5/16" high	16ga
A30C-NCH-18	2 5/16" ID	1/4" high	18ga
350C-NCH-16	2 1/2" ID	1/4" high	16ga
A40C-NCH-16	2 13/16" ID	1/4" high	16ga
100375-NCH-16	8 1/8" ID	3/8" high	16ga

Available with various size center holes and other hole patterns

SQUARE FLAT CAPS & SPECIALTY CAPS

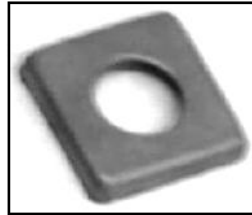

A17	3/4" square	1/8" high
S100	1" square	1/8" high
S125	1 1/4" square	1/4" high

ST75-18
Pyramid cap
3/4" square
5/16" high
Standard 18ga

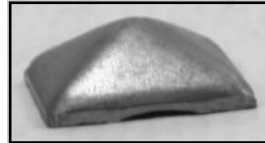
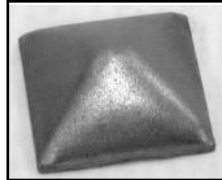

S158
Stepped cap
1 5/8" square
7/8" high

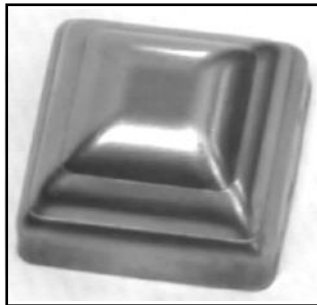

FURNITURE & ACCESSORY CAPS



0625-20
5/8" ID
1/4" high
Standard 20ga
Standard with no
center hole

075
3/4" ID
5/16" high
Standard 24ga
Standard with
no center hole
or 1/4" center hole



162-4
1" ID 5/8" high
1/4" center hole
Stepped cap
Available without
center hole
Standard 24ga



190-191 fount set



125-16
1 1/4" ID 5/16" high
Shown with .370 center hole
Standard 16ga



Shown no center hole



1901
2 1/8" ID
1/2" high

191
2 1/16" ID
3/4" high

SPECIALTY CAPS

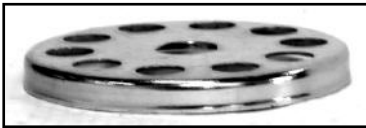

180C-10L
 2" ID 3/16" high
 10L pattern for crystals
 624 available w/24 holes - PN 624-24

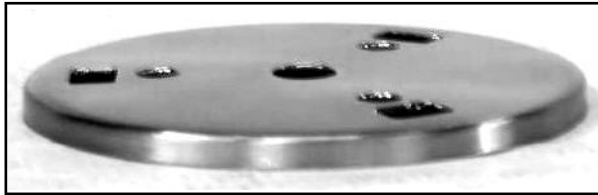

A57-3L
 3 7/16" ID
 5/16" high
 Socket hole pattern as shown
 also available with
 2L pattern- PN A57-2L



A57-3L
 Mated with 518 D
 Also mates with
 514, 539, 540

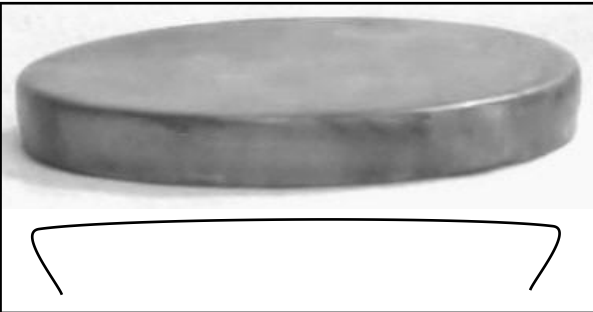

5102C
 3 1/4" ID
 3/8" high
 Turned in to fit glass
 Available w/wo center hole

Candle Cup Covers

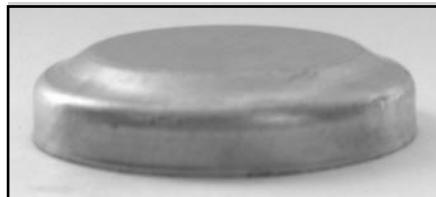

A23C
 1 3/4" ID 3/8" high
 512C
 3 7/16" ID 1/2" high
 Standard with no center hole



Custom caps
 with your
 logo or
 design
 available

Hangar Bar

Screw Collar Loop

Swag Lamp

Wall Back

Wall Sconce

CANOPIES

Embossed Canopies



Plain Canopies

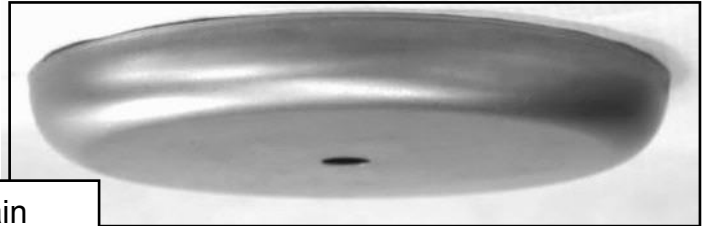

Hang Straight Canopies

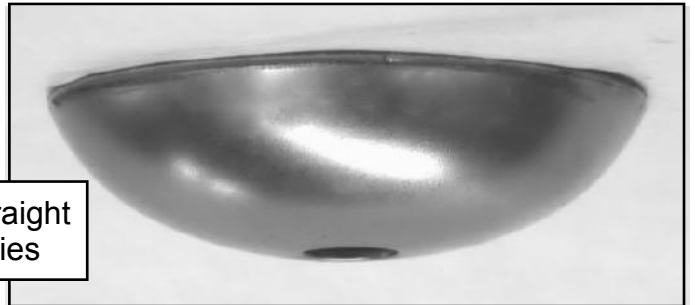

Square Canopies

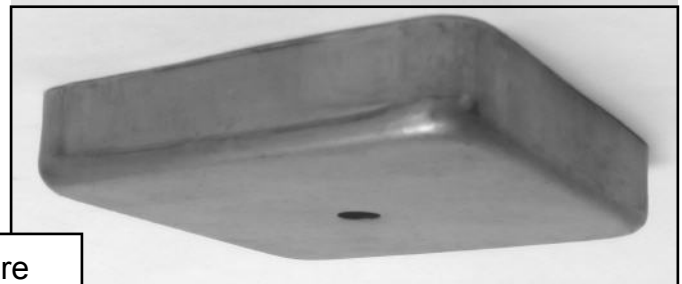

Oval Canopies



Specify your hole pattern!

CANOPIES

Hangar bar holes



Counter-sunk hangar bar holes



2L - swag holes



Screw collar loop



Convenience outlet



Center hole only



9/16" center hole



No center hole



1 1/4" screw collar loop



Hangar bar holes and screw collar loop

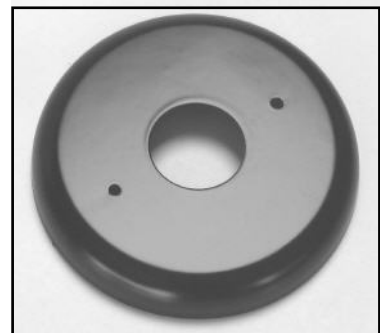

To Order
HOLE PATTERN OPTIONS
add the following
to part number

Part number only for center hole only

-NCH for no center hole

-H for center hole and 2-.187
hangar holes 2.75" CC

-HH for center hole and 2-.187
hangar holes 3.5" CC

-HS for center hole and 2-.187
counter-sunk hangar holes 2.75" CC

-9 for 9/16" center hole

-2L for center hole and 2 -.406 holes

-X for 1 1/16" screw collar hole

-XX for 1 1/4" screw collar hole

-CO for center hole and
convenience outlet hole

*For combination holes, add both to
part number - ie 720-HH-XX*

*Other options available
but not shown*

-7/8CH for 7/8" center hole

-1L for center hole and offset hole

-Key for center hole and key hole

-DD for double D center hole

*Custom hole patterns
available upon request*

FLAT CANOPIES

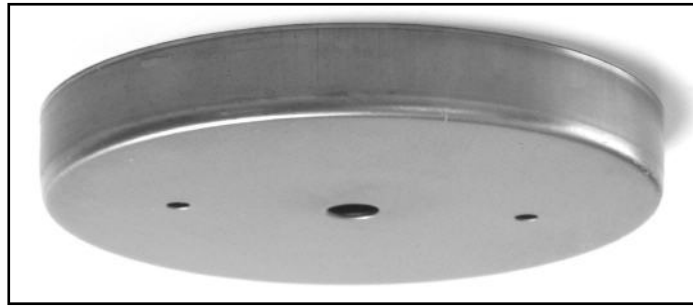

Part No.	OD	Height
626S	4 1/8"	3/8"
626	4 1/8"	1/2"
626D	4 1/8"	5/8"
627	4 1/8"	3/4"
A67	4 3/16"	3/8"
650-.5	4 1/2"	1/2"
650-.75	4 1/2"	3/4"
650-.825	4 1/2"	.825"
650-1	4 1/2"	1"
A64	4 5/16"	7/8"
A65	4 5/16"	1"
A66	4 5/16"	15/16"
776*	4 15/16"	11/16"
715*	5"	9/32"
770-3/4	5 1/8"	1"
770	5 1/8"	1 1/16"
801	6 1/8"	9/16"
807-3/4	6 1/8"	1"
807	6 1/8"	1 1/4"
898S	6 9/16"	1/2"
898-3/4	6 9/16"	1"
898	6 9/16"	1 1/4"
903	7 1/8"	1"
912	7 1/8"	1/2"
922	7 1/8"	1 5/16"
925	7 1/4"	1 1/4"
1003-3/4	8 1/8"	1"
1003	8 1/8"	1 1/4"
1101	9 1/8"	1"
11491	9 1/8"	3/8"
1201	10"	1"
1220	10"	1"
1222	10"	1"
1303	11"	1 1/16"

Most parts listed are standard in 24ga, many available in heavier gauges.
***Most commonly used, 776 available in 18, 20, 22ga.**

CANOPIES

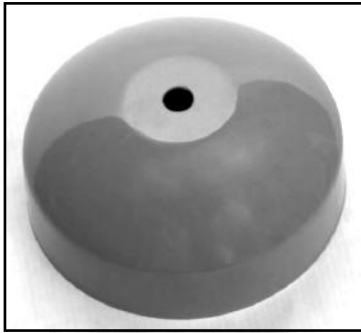
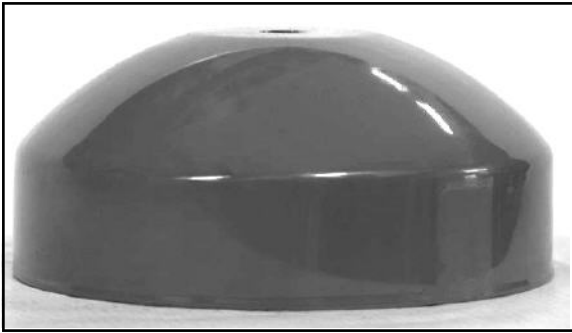

6454-20
 4 5/16" OD
 1 15/16" high
 Standard 20ga
 Shown powder coated
 gloss gray



614
 4 5/16" OD
 1 9/16" high
 Standard with
 hangar bar holes



650
 4 1/2" OD
 1/2" high



675
 4 3/4" OD
 1 1/2" high
 Available with
 1 3/32" center hole
 PN 675-1 3/32" CH



729
 4 15/16" OD
 1 1/16" high



795
 4 7/8" OD
 1 1/4" high
 Shown with 2L
 hole pattern
 PN 795-2L

Shown 795-2L

CANOPIES

704
5" OD
15/16" high
Available 22ga
PN 704-22

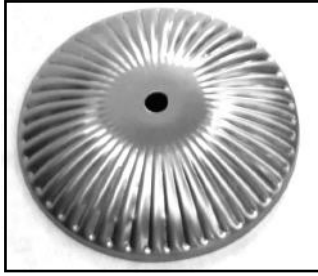

705
5" OD
5/8" high
Available in
18ga - PN 705-18
20ga - PN 705-20

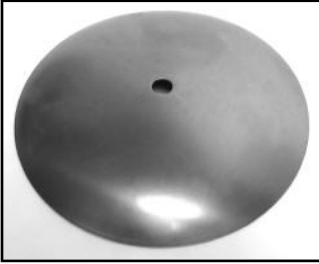

709
5" OD
15/16" high
3 3/4" flat
Available 22ga
PN 709-22



714
5" OD
7/8" high



7141-1.06CH
5"OD
1" high
Standard with
1.06 center hole



715
5" OD
9/32" high
Shown with
hangar bar holes
PN 715-H



Shown 715-H

CANOPIES



718
5" OD 1 1/4" high
Available 20ga - PN 718-20



719
5" OD 1 9/16" high



734
5" OD 1 5/16" high



794
5" OD 1 11/16" high

CANOPIES



707
5 1/16" OD 1 3/8" high



717
5 1/8" OD 1 5/16" high
Shown with 1 1/16" center hole- PN 717-X
Standard in 22ga



725
5 1/8" OD 5/8" high
Standard 20ga, available in 18ga - PN 725-18

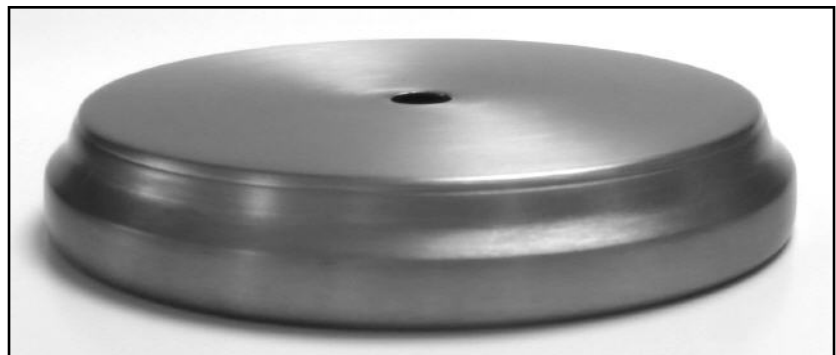

764
5 1/8" OD 7/8" high

CANOPIES



780
5 1/8" OD 1 1/2" high



7514-1.406CH
5 1/8" OD 15/16" high
Standard in 22ga with 1.406 center hole

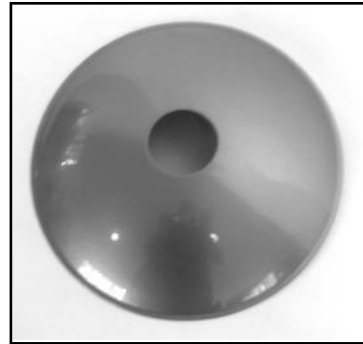

Shown with clear coat finish



739-1.328 CH
5 3/16" OD 15/16" high
Standard in 22ga with 1.328 center hole



CANOPIES



7125- Hang straight canopy
5 1/8" OD 2" high
5/8" standard center hole
Available with felt flange
PN 7125-F 1 3/4" high



700E
5 1/4" OD 1 5/16" high



701
5 1/4" OD 1 5/16" high

CANOPIES

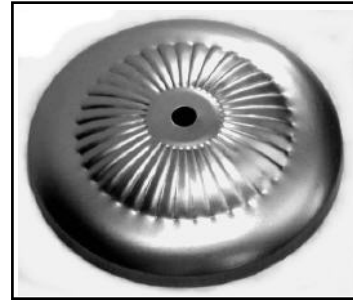

702
5 1/4" OD 1 1/8" high

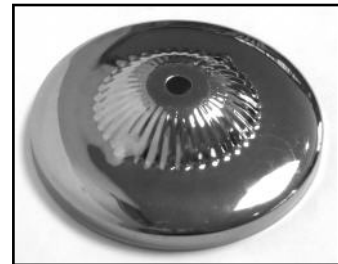

Shown in polished brass finish

710
5 1/4" OD 1 1/8" high



711
5 1/4" OD 1 3/8" high

CANOPIES

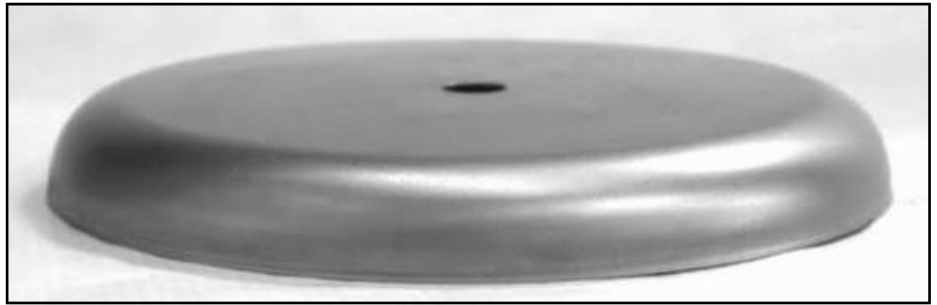

720
5 1/4" OD 1 1/16" high

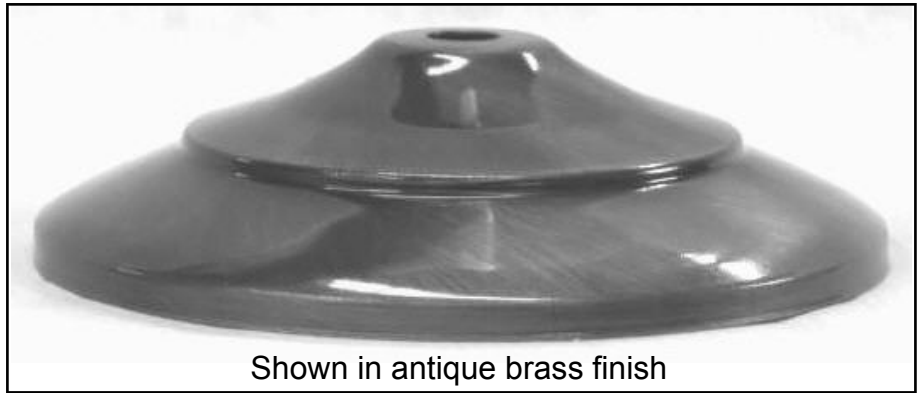

Shown in antique brass finish

730
5 1/4" OD 1 1/8" high



750
5 1/4" OD 1 5/8" high
Shown with hangar bar holes- PN 750-H

CANOPIES



755
5 1/4" OD 3/4" high

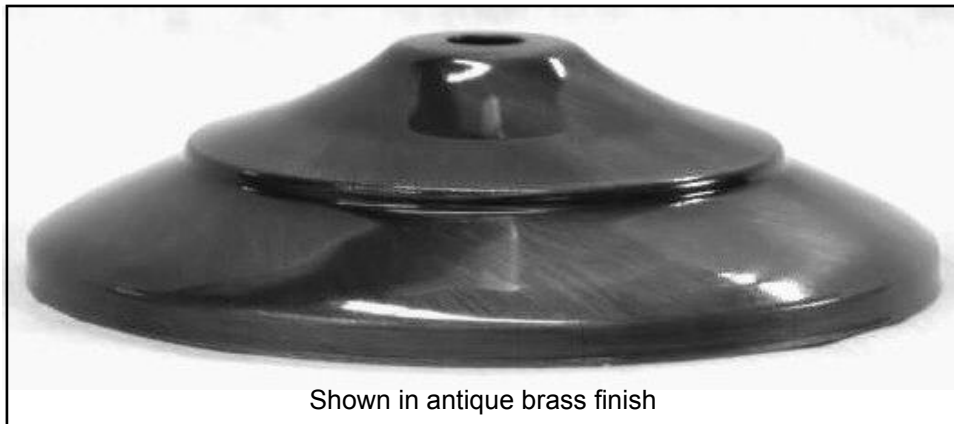

Shown in antique brass finish

760
5 1/2" OD 1 1/8" high



790
5 1/2" OD 1 13/16" high
Standard 22ga

CANOPIES



7973
5 5/8" OD 1 5/8" high
3 1/4" deep recess
Standard 22ga



Shown 7974-NCH



7974
5 5/8" OD 1 5/8" high
3 7/8" across flat
Standard 22ga, shown with no center hole



802
6 3/16" OD 1" high
Standard 22ga
Available 20ga - PN 802-20
Available 18ga - PN 802-18

CANOPIES



804
6 3/16" OD
1 1/4" high



805
6 3/16" OD 7/8" high
1 7/8" across flat
Available 18ga - PN 805-18



806
6 3/16" OD 1 3/8" high

CANOPIES



Shown in antique brass finish

850
6 1/16" OD
1 1/16" high
1 7/8" across flat

Available 22ga - PN 850-22



Many of the lamp bases are suitable for use as canopies, please check out the lamp base section for other options.



867
6 1/8" OD
1 1/4" high

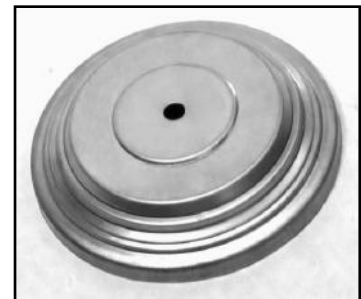

OVAL CANOPIES

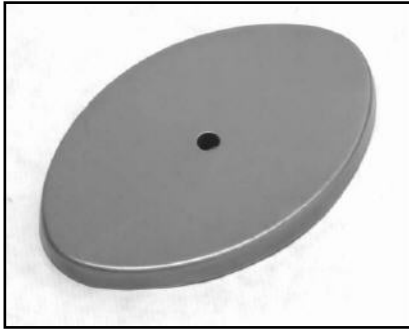

845-20
 6 7/8" x 4 9/16" ID
 1/2" high
 Standard 20ga
 Available 16ga - PN 845-16

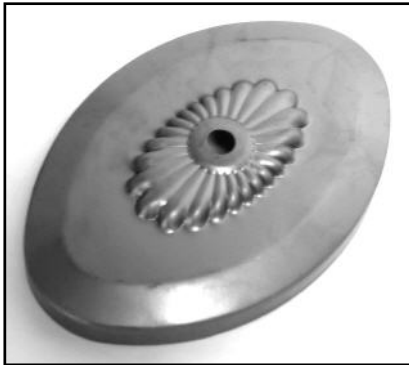

854
 6 7/8" x 4 9/16" ID
 1 1/8" high
 Standard 24ga



Shown with 3 1/2" CC
 hangar bar holes- 855-HH



855
 6 7/8" x 4 9/16" ID
 1 1/16" high
 Standard 22ga
 Available 20ga - PN 855-20



Shown tapped

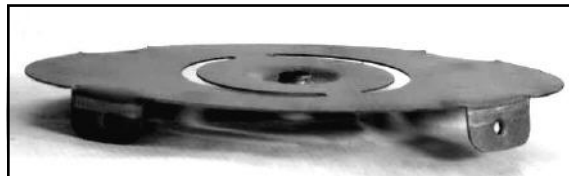

855FP
 6 7/8" x 4 9/16" OD
 9/16" high
 Available tapped
 Standard 24ga
 Available 20ga PN - 855-FP-20

SQUARE CANOPIES



4 1/2" SQUARE CANOPY



740	1 1/2" high	standard 24ga
741	15/16" high	standard 20ga
741-5/8	5/8" high	standard 20ga

Standard with .406 center hole to slip 1/8 pipe

HOLE PATTERN OPTIONS:

- No center hole - add -NCH to part number
- Center hole and off set hole - add -1L to part number
- Center hole and 2 -.406 holes - add -2L to part number
- Center hole and 2-.187 hangar holes 2.75" CC - add -H to part number
- Center hole and 2-.187 hangar holes 3.5" CC - add -HH to part number
- 1 1/16" screw collar center hole - add -X to part number
- 1 1/4" screw collar hole - add XX to part number
- 7/8" center hole - add -7/8CH to part number
- 9/16" center hole - add -9 to part number
- Cord hole on side - add -C to part number

Other hole patterns available upon request

WALL BACK CANOPY



1065
8 3/4" x 5 1/4" OD
9/16" high

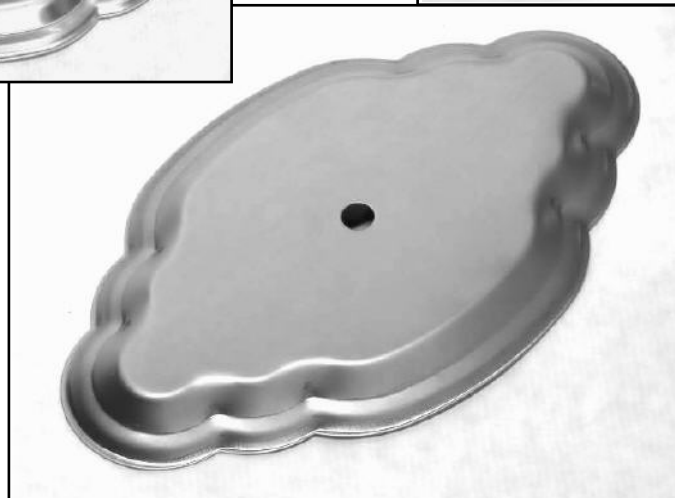

Available in
20,18, and 14ga
Add gauge
to part number
ie- 1065-14

WALL SCONCE



5192
3 1/2" OD
3/4" high
3/16" offset hole

Available without offset hole

Various views of the 5192 shown here
Shown above in polished brass finish

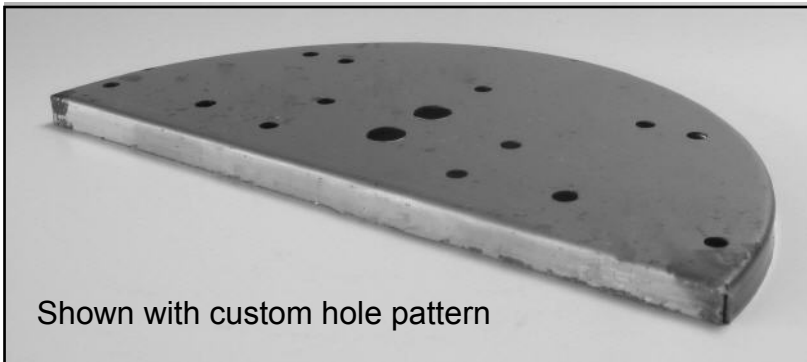
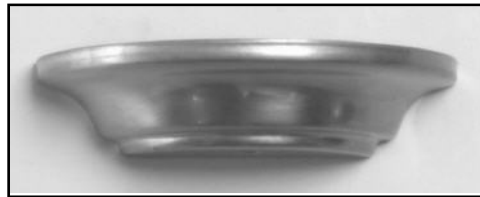

Shown with custom hole pattern

1149
9 1/8" OD
4 9/16" wide
3/8" high

WALL BACK



201-614
Wall back

Standard with
hangar bar holes



C
U
P
S
&
G
L
A
S
S
H
O
L
D
E
R
S



CUPS & PANS



BATH BAR CUPS



SOCKET CUPS

SHAPED &
FLARED



ROLLED
GLASSHOLDER



EMBOSSSED &
TAPPED

HALF BALLS

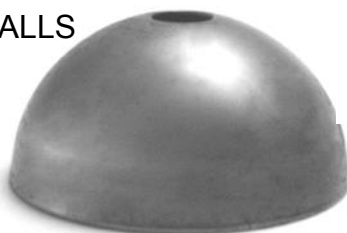

VENTED



BALL
SETS

STRAIGHT CUPS

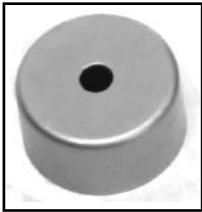

1801

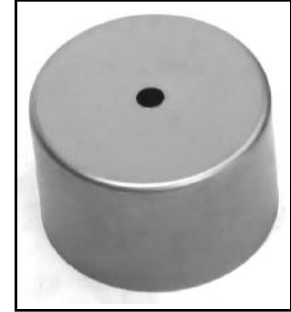

528

Part No	I.D.	Height	Part Variations
18078	1 15/16"	7/8"	
1801	1 15/16"	1"	
180-1 1/8	1 15/16"	1 1/8"	
180	1 15/16"	1 3/16"	
184	1 15/16"	1 5/16"	
1845	1 15/16"	1 1/2"	standard 20ga
301-1	2 1/4"	1"	standard 22ga
301	2 1/4"	1 1/4"	
303	2 15/16"	2 3/4"	available 1 5/8" and 2 5/8" high
304	2"	3 1/4"	available vented
305	2"	2 1/4"	available 2", 2 3/8", 3" high
3992	1 11/16"	2 1/16"	available vented
441S	2 5/8"	15/16"	
441	2 5/8"	1 1/8"	
442	2 11/16"	1 3/8"	
Q48	2 15/16"	1"	
445	3 1/16"	1 1/2"	available 1" high
447	2 3/4"	1 3/4"	
543	3 5/32"	1 1/4"	
527	3 11/32"	1 3/8"	available tapped - PN 502
528	3 9/16"	2 11/16"	
A69-22	3 15/16"	1 1/4"	different heights available
A60	4 9/32"	1 1/4"	available tapped - PN A60-T
603	4 5/16"	1 1/2"	available tapped - PN 603-T
7705-24	5 1/16"	1 1/2"	
7900	5 7/16"	2"	radiused corners, available w/vents
791	5 7/16"	1 1/2"	
7915	5 7/16"	1 3/4"	
8005	6 1/16"	1 3/4"	
8985	6 1/2"	1 3/4"	
950	7 1/16"	1 3/4"	
1050	8 1/16"	1 3/4"	

STRAIGHT PANS



Part No.	I.D.	Height	Part No.	I.D.	Height
180S	1 15/16"	1/4"	650-1	4 7/16"	1"
180S-D	1 15/16"	5/8"	650C	4 1/2"	3/8"
Q30	2 1/4"	1/2"	776	4 7/8"	11/16"
4391	2 5/8"	3/4"	770-3/4	5 1/16"	1"
405	2 11/16"	1/2"	770	5 1/16"	1 1/16"
408S	3 1/16"	3/8"	801	6 1/16"	9/16"
408	3 1/16"	1/2"	807-3/4	6 1/16"	1"
541S	3 1/8"	3/8"	807	6 1/16"	1 1/4"
541	3 1/8"	1/2"	898S	6 1/2"	1/2"
542	3 5/32"	3/4"	898-3/4	6 1/2"	1"
526	3 11/32"	1"	898	6 1/2"	1 1/4"
522	3 13/32"	1/2"	903	7 1/16"	1"
524	3 13/32"	3/4"	912	7 1/16"	1/2"
A56	3 1/2"	5/8"	922	7 1/16"	1 5/16"
626S	4 1/16"	3/8"	925	7 3/16"	1 1/4"
626	4 1/16"	1/2"	1003-3/4	8 1/16"	1"
626D	4 1/16"	5/8"	1003	8 1/16"	1 1/4"
627	4 1/16"	3/4"	1101	9 1/16"	1"
A67	4 1/4"	3/8"	11491	9 1/16"	3/8"
A64	4 9/32"	7/8"	1201	9 15/16"	1"
A65	4 9/32"	1"	1220	9 15/16"	1"
A66	4 9/32"	15/16"	1222	9 15/16"	1"
650-.5	4 7/16"	1/2"	1301	10 15/16"	1"
650-.75	4 7/16"	3/4"	1303	10 15/16"	1 1/16"
650-.825	4 7/16"	.825"			

STANDARD TAPPED PANS

Part No.	I.D.	Height
526-T	3 11/32"	1"
502	3 11/32"	1 3/8"
501	3 13/32"	3/4"
505	3 1/2"	5/8"
626-T	4 1/16"	1/2"
627-T	4 1/16"	3/4" Available vented
601	4 9/32"	7/8"
A65-T	4 9/32"	1"
605-T	4 9/32"	15/16"

SQUARE PANS



Part No.	Diameter	Height
740	4 1/2"	1 1/4"
741	4 1/2"	15/16"
741-5/8	4 1/2"	5/8"

SOCKET CUPS

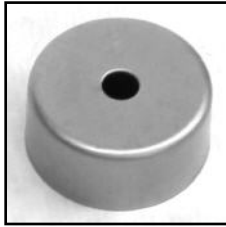

1801 1 15/16" ID 1" high	180 1 15/16" ID 1 3/16" high	184 1 15/16" ID 1 5/16" high
---------------------------------------	---	---



183 1 15/16" ID 1 3/16" high	185 1 15/16" ID 1 7/16" high	1851 1 15/16" ID 1" high
---	---	---------------------------------------

Screw in socket cup



186 1 15/16" ID 1 3/16" high 1 1/2" center	187 1 15/16" ID 1 3/16" high 1 7/16" center
--	---



188
 1 15/16" ID
 1 3/16" high
 Snap in socket cup

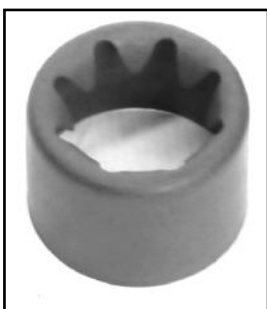

189
 1 15/16" ID
 1 7/16" high
 Push on socket cup



3993
 2" OD at flare
 1 1/2" ID
 5/8" high

SOCKET CUPS

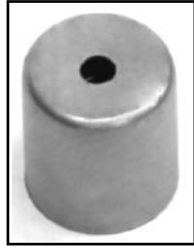

3992
1 11/16" ID
2 1/16" high



303
2 5/16" ID
2 3/4" high
Available vented - PN 303-V
Available with side holes
Also available 1 5/8" & 2 5/8" high



304
2" ID
3 1/4" high
Available vented - PN 304-V
Available with side holes
Also available 2", 2 3/8", & 3" high

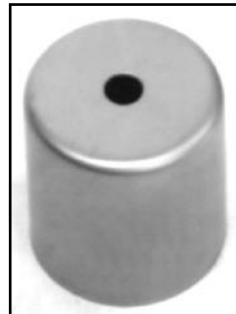

305
2" ID
2 1/4" high

439
2 11/16" ID
3/4" high
Screw in socket cup
Standard with rolled edge



Shown in antique brass

CUPS / GLASSHOLDERS



A18
1 5/8" ID at flare
1" high



A181
2" OD at flare
1 1/2" ID
5/8" high

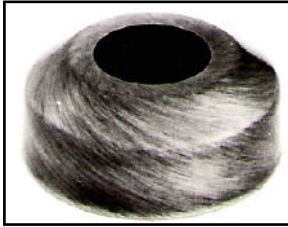

A19
1 11/16" ID
3/4" high
3/4" center hole
Shown in antique brass finish



A20R
1 11/16" ID
1 5/16" high
Standard rolled edge



A20
1 11/16" ID
1 1/2" high

A24
1 11/16" ID
1 1/4" high



220
1 3/4" ID
2" OD at flare
1 9/16" high

Shown in antique brass finish



201
1 13/16" ID
2 1/16" OD at flare
2 9/16" high
Shown in brushed nickel finish

CUPS / GLASSHOLDERS

307
2" ID
2" high
1 7/16" across closed end

Available tapped - PN 307-T

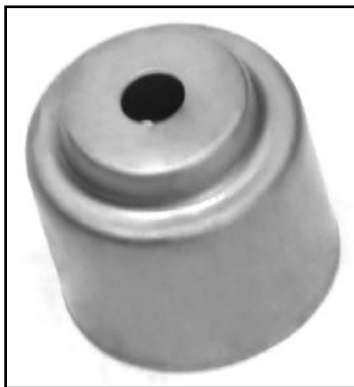

221 221-D
2 1/4" ID 2 1/4" ID
1 7/8" high 2 1/8" high

Available tapped-see photo
PN 221D-T



Shown 221-D-Tapped

230 231
2 1/4" ID 2 3/16" ID
2" high 2" high



2301
2 1/4" ID
1 3/8" high

Shown no center hole



A37
2 1/4" ID
1 1/4" high

Available flanged - PN A37-F
Available 18ga - PN A37-18



CUPS / GLASSHOLDERS



302
2 1/4" ID
1 1/2" high
Available tapped - PN 302-T



316
2 1/4" ID
1 3/4" high



358
2 1/4" ID
1 1/4" high

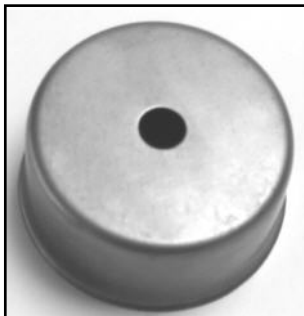

311
2 5/16" ID
1" high
Flared edge
Available tapped - PN 311-T



312
2 5/16" ID
1 5/8" high
Flared edge
Available tapped
PN 312-T

CUPS / GLASSHOLDERS

345
2 1/2" ID
1 3/8" high

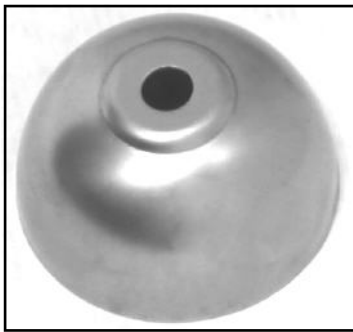

351
2 1/2" ID
1 1/4" high



420
2 1/16" ID
2 3/4" OD at flare
1 13/32" high



449
2 15/16" ID
1 7/8" high



Q49
2 15/16" ID
1" high



CUPS / GLASSHOLDERS



458
 2 15/16" ID
 1 5/8" high



490
 3" ID
 1 3/8" high
 Turned in edge

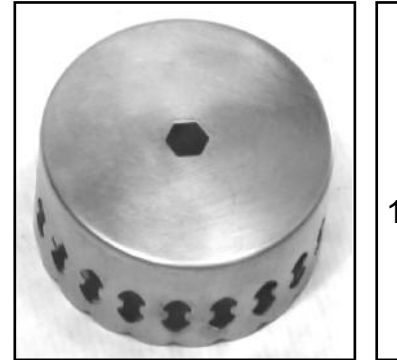
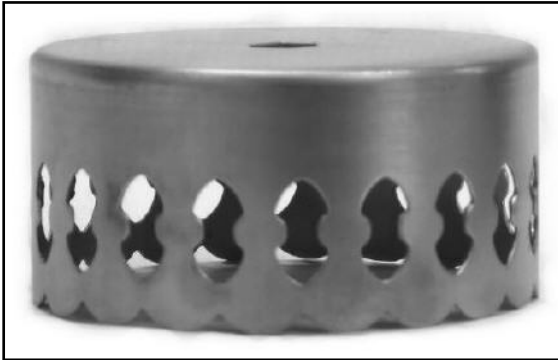

442 CAS	445 CAS
2 11/16" ID	3 1/16" ID
1 3/8" high	1 1/2" high

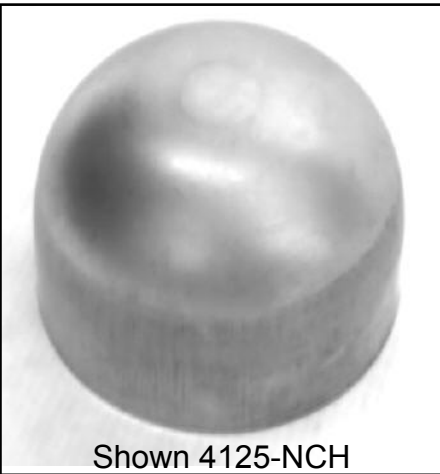

4125
 3 1/16" ID
 2 7/16" high
 Shown with
 no center hole

Shown 4125-NCH



549
 3 1/16" ID
 1 3/8" high

CUPS / GLASSHOLDERS

537
3 5/32" ID
1 3/4" high



538
3 5/32" ID
1 3/8" high



539
3 5/32" ID
15/16" high

Shown with
no center hole



540
3 5/32" ID
1 3/8" high



558
3 5/32" ID
1 5/16" high



CUPS / GLASSHOLDERS



Shown 504-NCH

504
 3 11/32" ID
 2 1/16" high
 Available tapped
 PN 504-T
 as shown
 on left



507
 3 11/32" ID
 7/8" high



Shown 510-T with key hole



Shown in polished flemish finish

510
 3 11/32" ID
 2 3/4" high



Shown 544-T



544
 3 11/32" ID
 1 13/32" high

CUPS / GLASSHOLDERS



546
 3 11/32" ID
 2 1/2" high

Shown tapped & vented - PN 546 TV



547
 3 11/32" ID
 2 1/4" high

Shown with rolled edge



552
 3 11/32" ID 1 1/8" high



594
 3 11/32" ID 2 1/4" high
 Available tapped - PN 594-T
 Available rolled edge - PN 594-R
 Rolled & tapped - PN 594R-T



Shown 594-R

CUPS / GLASSHOLDERS



548
3 13/32" ID 1 1/16" high



529
3 11/16" ID
2 3/16" high



A68
4" ID 1 1/4" high

CUPS / GLASSHOLDERS



602
 4 9/32" ID
 3 1/16" high
 Straight
 Available tapped

602-R
 4 9/32" ID
 2 3/4" high
 Rolled edge



Shown 602-T in antique brass finish



606
 4 9/32" ID 1 5/16" high
 Available tapped - PN 606-T



608
 4 7/32" ID
 1 3/16" high

609
 4 9/32" ID
 1 1/8" high



CUPS / GLASSHOLDERS



Shown 611-NCH



611
 4 9/32" ID
 2 1/8" high
 Shown no center hole
 Available tapped - PN 611-T



615
 4 5/16" ID 1 1/2" high
 Available tapped - PN 615-T
 Available with rolled edge - PN 615-R
 Available with castle design - PN 615-CAS
 Combine options, ie. 615-T-R-CAS

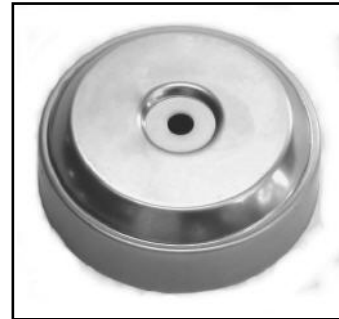

Shown 615-R-CAS

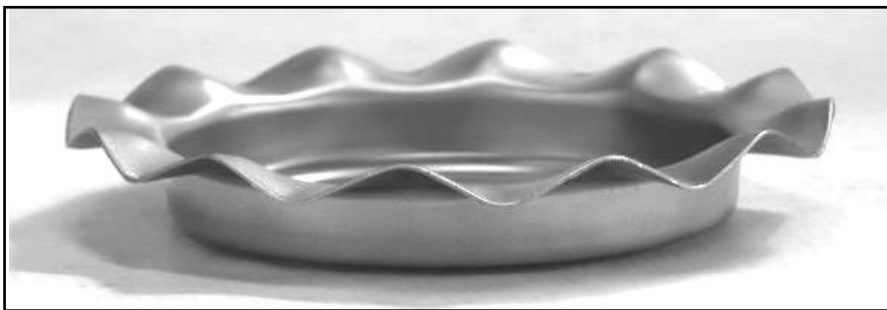

680
 4 9/16" OD 3 7/16" ID
 13/16" high



EMBOSSED CUPS/GLASSHOLDERS

200
 1 15/16" ID
 1 1/2" high

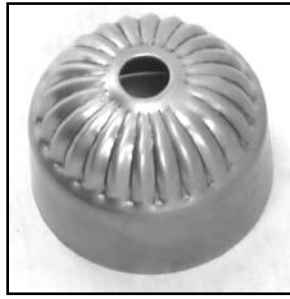

Available tapped - PN 310-T
 Available vented - PN 310-V
 Available tapped & vented - PN 310-TV

310
 2 5/16" ID
 1 7/16" high



403
 2 11/16" ID
 1 5/8" high
 Standard with
 rolled edge

Available tapped - PN 403-T
 Available straight - PN 400



487
 2 15/16" ID
 1 11/16" high



A49E
 3" ID
 1 13/16" high



EMBOSSED CUPS



500E
 3 11/32" ID
 1 7/8" high
 Available tapped
 PN 500E-T
 Available vented
 PN 500E-V
 Tapped and vented
 PN 500E-TV



Shown 508T-V



508V
 3 11/32" ID
 1 1/2" high
 flared edge
 Standard vented
 Available tapped
 PN 508-TV



604V
 4" ID
 1 5/8" high
 Standard vented,
 available without
 PN 604
 Available tapped
 PN 604-TV

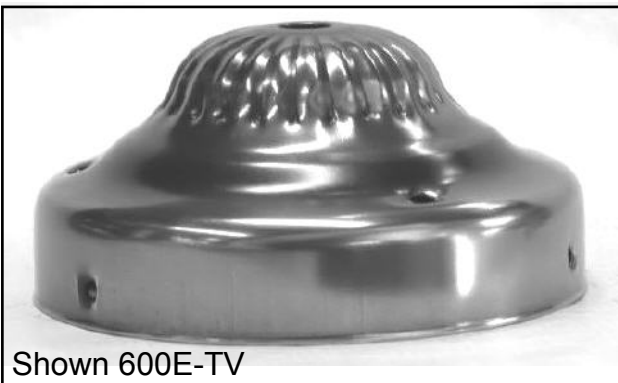

Shown 600E-TV



600E
 4 9/32" ID
 2 1/8" high
 Available vented
 PN 600E-V
 Available tapped
 PN 600E-T
 Tapped and vented
 PN 600E-TV



610
 4 1/4" ID
 1 1/2" high

HALF BALLS - BALL SETS

Part No.	ID	Height	Variation
112	1 1/2"	3/4"	standard 20ga
212	2"	1"	standard 20ga 3/16" center hole
313	2 1/4"	1 3/16"	avail 22, 18ga
3141	2 1/4"	1 5/16"	avail 22, 18ga
411	2 11/16"	1 3/8"	
412	3 1/16"	1 5/8"	available 20ga
612	4 5/16"	2 3/16"	available 18ga
712	5 1/8"	2 9/16"	available 20ga
313-712 half balls are standard in 24ga			



Part No.	ID	Height	Variation
314	2 5/16"	1 3/16"	available 22ga
413	3 1/8"	1 5/8"	available 20ga
613	4 3/8"	2 5/16"	



Part No.	ID	Height	Variation
3142	2 1/4"	1 3/16"	available 22ga
4132	2 15/16"	1 1/2"	available 20ga
6132	4 3/16"	2 3/8"	



Part No.	OD	Height
313-314	2 5/16"	2 5/16"
412-4122	3 1/8"	3 1/8"
612-6122	4 3/8"	4 3/8"

Part No.	OD	Height
313-314	2 3/8"	2 5/16"
412-413	3 3/16"	3 1/8"
612-613	4 7/16"	4 3/8"

NECKLESS BALL HOLDERS



481	3 7/16" OD	3/8" high
621	4 1/8" OD	1/2" high
705	5" OD	5/8" high
7545	5 1/2" OD	5/8" high
802	6 1/8" OD	1" high

See bobeches for other options



1205
10" OD
1 13/16" high
5/8" center hole
Standard in 22ga

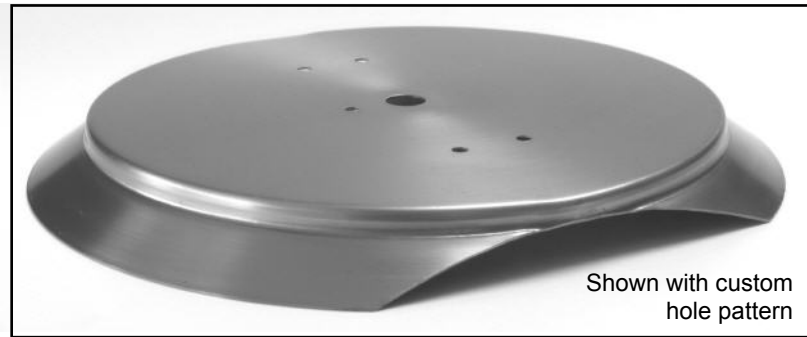

Shown with custom hole pattern



1205-LINER
9 3/8" OD at widest point
13/16" high
1/2" center hole - standard 22ga

BENT GLASS GLASSHOLDERS



746



781

4 1/2" square
1 1/2" high
3/16" center hole



Red cross hole located next to outside rib

Red cross hole located next to inside rib

Hangar holes and other hole options available



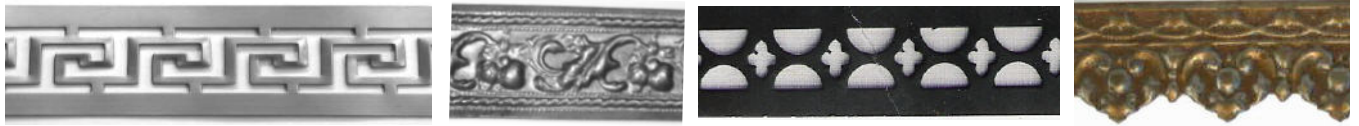

FILIGREE

**A
N
D**

**B
A
N
D
I
N
G**

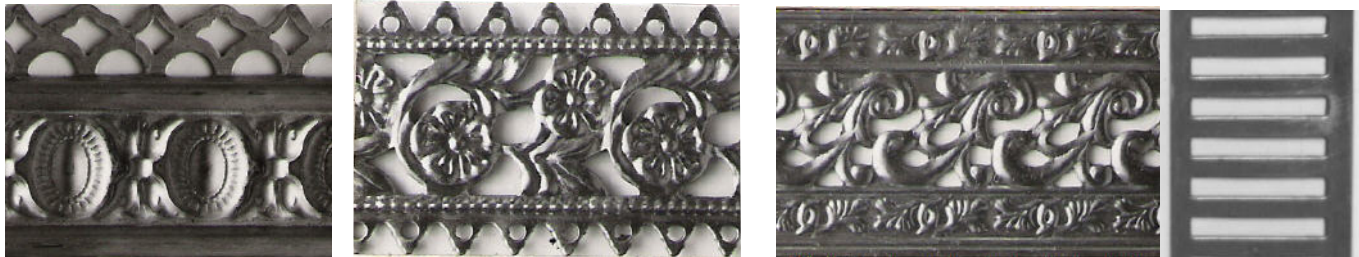

BANDING



P-1 (1"-1 1/4")



P-9 (1"-1 1/4")

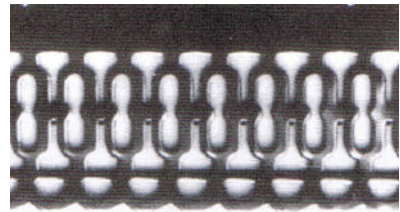

P-16 (1 1/4")



P-2 (3/4"-1 1/4")



P-10 (3/4"-1 1/4")

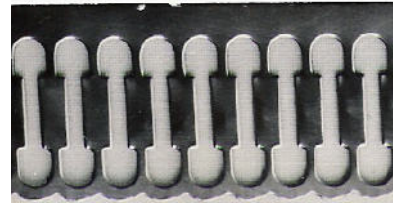

P-18 (1")



P-3 (3/4"-1 1/4")



P-12 (1/2")

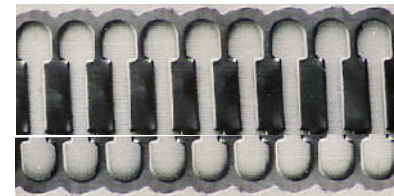

P-19 (1")



P-4 (3/4"-1 1/4")

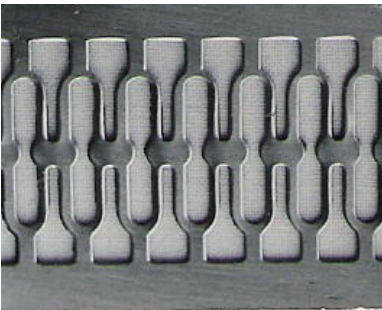

P-13 (1 1/2"-2 1/4")

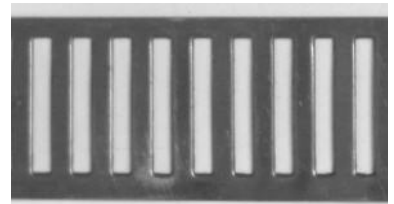

P-20 (1"-1 1/2")



P-5 (3/4"-1 1/4")

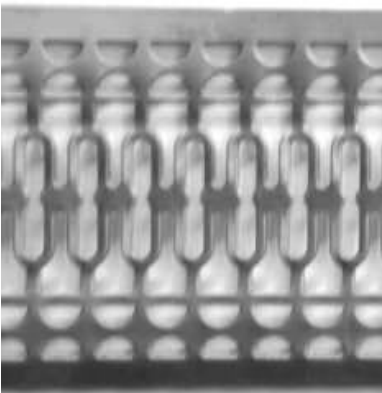

P-14 (2"-2 1/4")

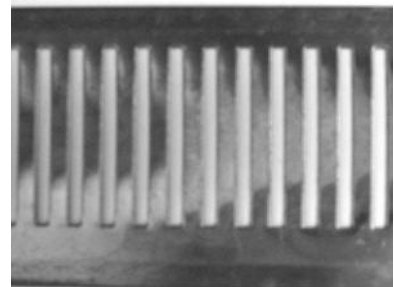

P-21 (1 3/4"-2 1/2")

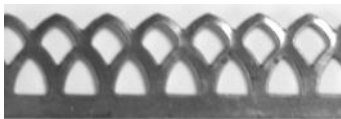

P-6 (1/2")

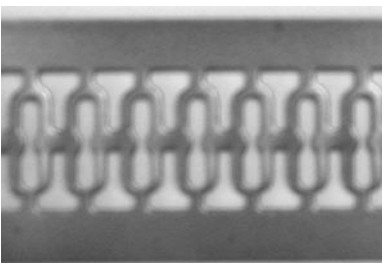

P-15 (1"-1 1/4")

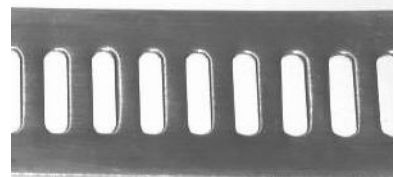

P-22 (3/4"-1")



P-7 (3/4")

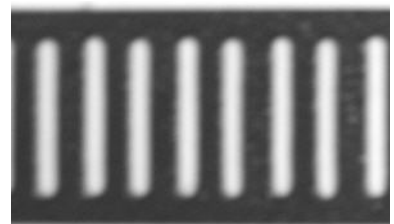

P-23 (1"-1 1/2")

**Bandings are available
in brass, steel, or
copper.
Standard in 24ga.**

BANDING

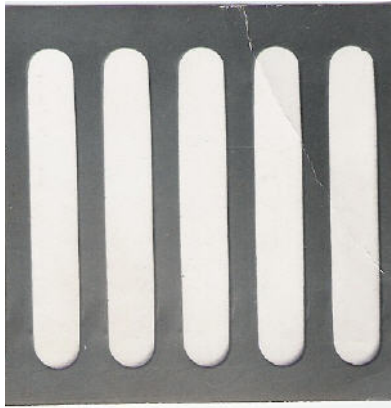

P-24 (2 3/4")

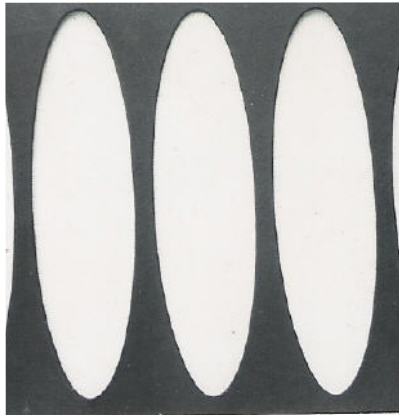

P-25 (2 3/4")



P-28 (1"-1 1/4")

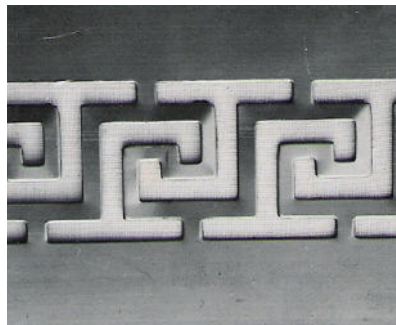

P-30 (1 3/4"-2 1/4")



E-31 (3/8")



E-32 (7/16")



E-33 (1 1/4"-3")

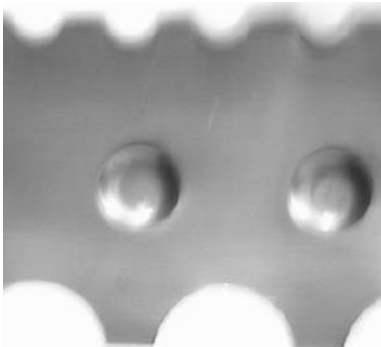

PE-35 (2 1/4")

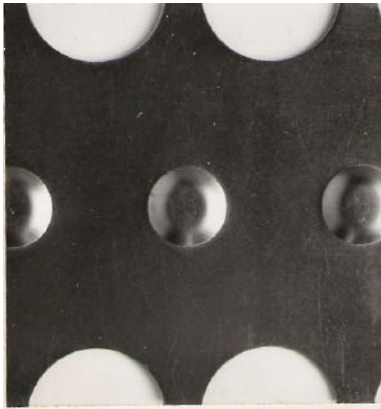

PE-36 (3")

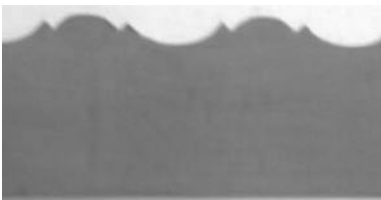

P-39 (1"-2 1/4")



P-40 (1"-1 1/4")

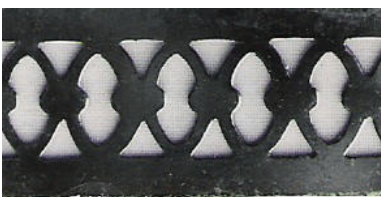

P-41 (1"-1 1/4")



P-42 (3/4"-1 1/4")

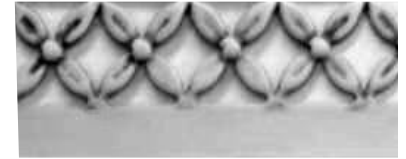

PE-43 (7/8")

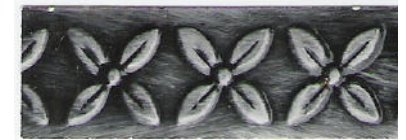

E-44 (7/8"-1")



PE-44 (7/8"-1")

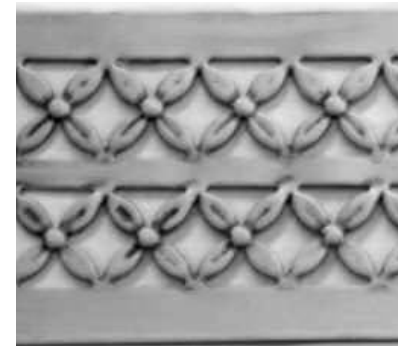

PE-45 (2 1/4"-3")

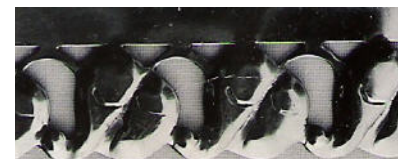

PE-46 (7/8"-1 1/4")



E-47 (3/4"-6")

E-47 or E-48 can be added to any banding that has solid border.

BANDING



E-48 (1"-6")

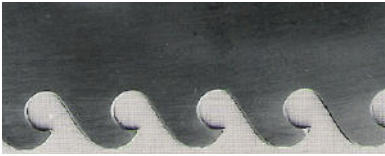

P-49 (1"-1 1/4")

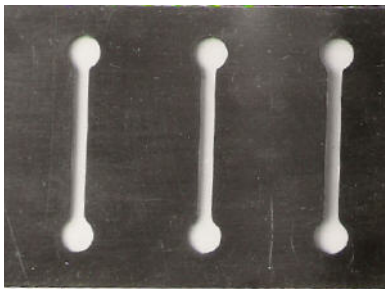

P-50 (1 3/4")



E-51 (7/8"-1 1/4")



E-52 (1/2"-1")

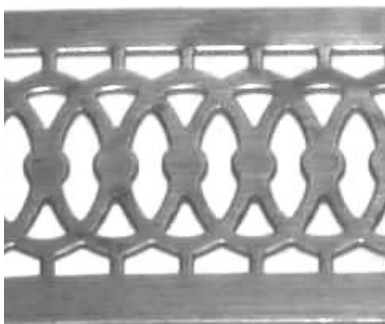

P-53 (1 3/4"-2 1/4")



P-55 (1/2"-2 1/4")



P-56 (3/4"-2 1/4")

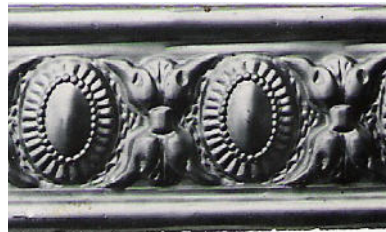

E-57 (1 1/4")



PE-58 (1 3/4")



PE-59 (2 1/4")

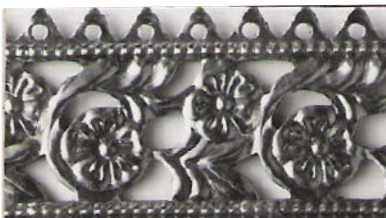

PE-60 (1 1/4")
E-60 (1 1/4")



PE-61 (1"-1 1/4")
E-61 (1"-1 1/4")

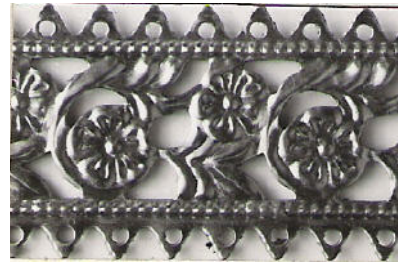

PE-62 (1 1/4")
E-62 (1 1/4")



PE_63 (2"-2 1/4")
E-63 (2"-2 1/4")

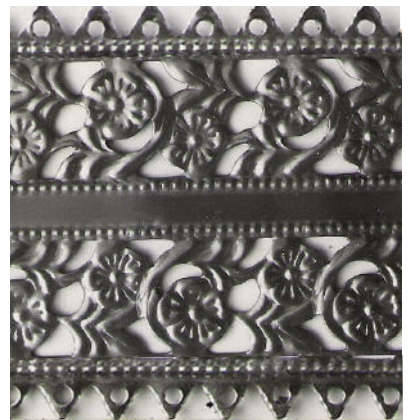

PE-64 (2 1/4")
E-64 (2 1/4")

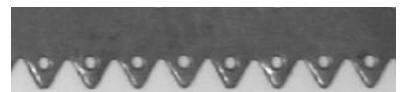

P-65 (1/2"-2 1/4")

P-65 can be added to any banding with a solid border.

***E = embossed
P = perforated
PE = perforated & embossed***

BANDING

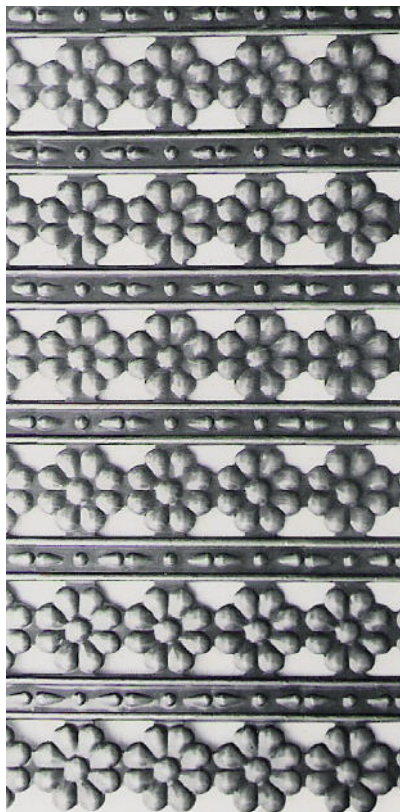

PE-69 (1")

Available with center of flower cut out

PN- PE-68 (1")

Both available with solid borders from 1"-6" wide



E-70 (7/8")



E-71 (1 1/2")



E-74 (2")



E-745 (1 1/8")



E-75 (1 3/4"-6")



E-76 (1 3/4"-6")



PE-84 (1 1/4")

E-84 (1 1/4")



PE-86 (2 1/2")

E-86 (2 1/2")



PE-87 (7/8")

E-87 (7/8")



PE-88 (1 1/4")

E-88 (1 1/4")



PE-89 (1 1/2")

E-89 (1 1/2")



PE-90 (1 3/4")

E-90 (1 3/4")



PE-91 (2")

E-91 (2")

BANDING

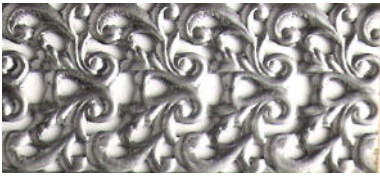

PE-92 (1 1/8")
E-92 (1 1/8")



PE-93 (1 1/2")
E-93 (1 1/2")



PE-94 (1 3/4"-2")
E-94 (1 3/4"-2")



PE-95 (2 5/8")
E-95 (2 5/8")



PE-96 (3")
E-96 (3")



PE-97 (3 1/4")
E-97 (3 1/4")



PE-98 (3 1/2")
E-98 (3 1/2")

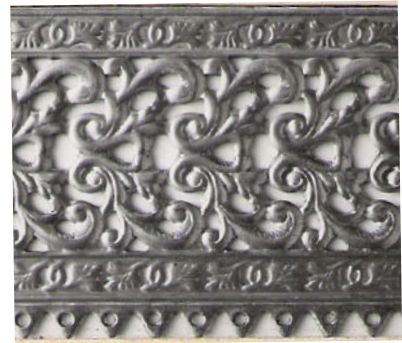

PE-99 (2")
E-99 (2")



PE-100 (1 1/2")
E-100 (1 1/2")



E-101 (3/8")



E-102 (1"-2")

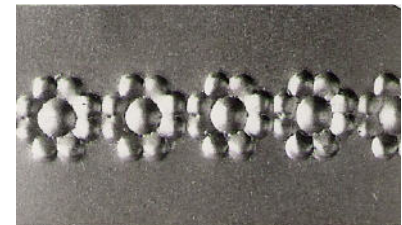

E-103 (1 1/8"-3")



P-119 (1 1/4")

E = embossed
P = perforated
PE = embossed & perforated

BANDING

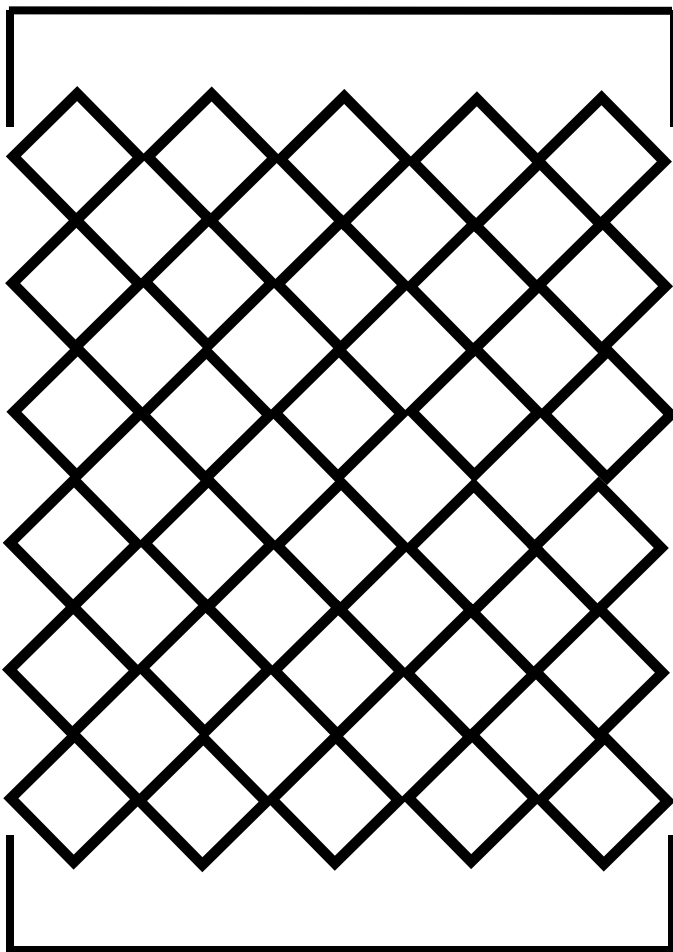

P54 (5")
solid border with
4" diamond pattern

These are line drawings of additional bandings that are available.

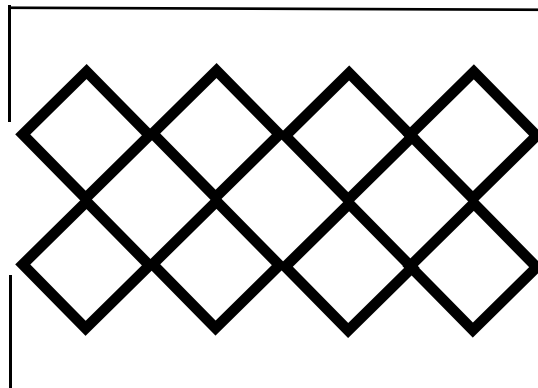

P54 (2 3/16")
solid border with

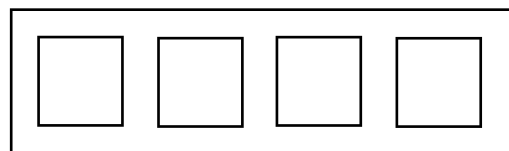

Mission Style Banding
1/2" wide to 1 1/4" wide
Perforated squares are 3/8" to 1"
Pns P-S375, P-S50, P-S625, P-S75, P-S100

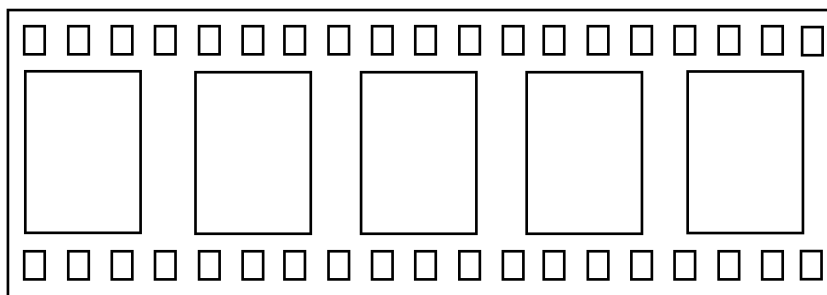

P-1562 (1 9/16")
Large holes - 1" x 0.625"
Small holes - 0.124" x 0.09"



Customer Owned Banding
Wild Animal Design

Ask how you can have your design made.

SAMPLES OF BANDED CUPS & HOLDERS

Any cup or glassholder can be banded,
choose part and banding for quote.



401 with 2" DIA banding ring
Using PE-84
PN 401-84



500E with E-119 banding
PN 500E-119
Shown tapped



602 with PE-100 banding
PN 602-100
Shown tapped



548 with PE-100 banding
PN 548-100
Shown tapped



602 with PE-94 banding
PN 602-94
Shown tapped



627 with PE-100
PN 627-100
Shown tapped



S
H
O
T

FOUNTS

PART Nos.	OD X HEIGHT	COMMENTS
112-112	1 1/2" X 1 1/2"	requires welding
A11-112	1 9/16" X 1 3/16"	112 standard in 20 ga
A20C-TI-112	1 9/16" X 13/16"	A20C turned in to fit 112
A21-A22	1 3/4" X 15/16"	vase cap/vase cap
A22-A18	1 3/4" X 1 7/16"	vase cap/flared cup
212-212	2 1/16" X 2 1/16"	requires welding - standard 20ga
182-212	2 1/16" X 1 9/16"	212 standard in 20 ga
1811-212	2 1/16" X 1 3/8"	vase cap/half ball
190-191	2 1/16" X 1 3/8"	standard 20 ga
230-231	2 5/16" X 3 7/8"	mated fluted cups
313-3142	2 5/16" X 2 5/8"	inside fit half ball set
A31-A32	2 3/8" X 1 3/8"	vase cap/vase cap
A31-313	2 3/8" X 2"	vase cap/half ball
A32-314	2 3/8" X 2"	vase cap/expanded half ball
313-314	2 3/8" X 2 5/16"	expanded half ball set
320-313	2 3/8" X 2"	vase cap/half ball
358-314	2 3/8" X 2 3/8"	stepped cup/expanded half ball
364-313	2 3/8" X 2"	vase cap/half ball
A31-358	2 3/8" X 1 3/4"	vase cap/stepped cup
320-358	2 3/8" X 1 3/4"	vase cap/stepped cup
3669-358	2 7/16" X 2"	turned in vase cap/stepped cap
A40-A41	2 13/16" X 1 5/8"	vase cap/vase cap
A40C-458	3" X 1 11/16"	flat cover fits inside
Q49-485	3" X 1 5/8"	vase cap/vase cap
A48C-458	3" X 1 3/4"	flat cover fits outside
Q49-490	3" X 2"	vase cap/turned in deep vase cap
490-48511	3" X 3 1/8"	turned in vase cap/vase cap
490-449	3" X 2 7/8"	turned in vase cap/shaped cup
490-459	3" X 2 15/16"	turned in vase cap/ 18ga shaped
482-458	3" X 2 3/8"	vase cap/stepped cup
485-458	3" X 2 3/8"	vase cap/stepped cup
482-483	3 1/16" X 1 1/16"	vase cap/vase cap
483-485	3 1/16" X 1 1/16"	vase cap/vase cap
484-485	3 1/16" X 1 1/16"	vase cap/vase cap
483-48511	3 1/16" X 1 1/4"	vase cap/vase cap
412-4122	3 1/8" X 3 1/8"	inside fit half ball set
48511-5386	3 1/8" X 1 9/16"	vase cap/turned in vase cap
412-413	3 3/16" X 3 1/18"	expanded half ball set
A44-412	3 3/16" X 2 1/8"	decorative vase cap/half ball
464-412	3 3/16" X 2 1/4"	vase cap/half ball
484-413	3 3/16" X 2 1/4"	vase cap/expanded half ball
408S-541S	3 3/16" X 3/8"	pan/pan used as spacer
558CI-3L-558	3 3/16" X 1 3/8"	flat cover fits inside-w/wo 3 holes
558CI-3L-539	3 3/16" X 1"	flat cover fits inside
558CI-3L-540	3 3/16" X 1 3/8"	flat cover fits inside
518-519	3 7/16" X 1 1/4"	flat vase cap/flat vase cap
567-518	3 1/2" X 1 1/4"	vase cap/flat vase cap
A57-3L-518	3 1/2" X 1"	socket cap/flat vase cap

FOUNTS

PART Nos.	OD X HEIGHT	COMMENTS
A57C-3L-514	3 9/16" X 1 1/8"	socket cap fits inside - 3L or 2L
520-521	3 9/16" X 1 5/8"	vase cap/vase cap
530-531	3 9/16" X 1 3/4"	vase cap/vase cap
580-581	3 9/16" X 2"	vase cap/vase cap
564-514	3 5/8" X 1 3/4"	vase cap/vase cap
A51-Q52	3 5/8" X 2 1/4"	vase cap/vase cap
618-619	4 5/16" X 2 1/2"	vase cap/vase cap
618-6122	4 5/16" X 3 1/2"	vase cap/inside fit half ball
630-6122	4 3/8" X 3 3/16"	vase cap/inside fit half ball
612-6122	4 3/8" X 4 3/8"	inside fit half ball set
6454-640-20	4 3/8" X 1 7/8"	domed cup/flat pan w/holes
630-631	4 7/16" X 1 7/8"	vase cap/vase cap
608-609	4 7/16" X 2 1/8"	available with bottom holes
631-612	4 7/16" X 3 3/16"	vase cap/half ball
612-613	4 7/16" X 4 3/8"	expanded half ball set
759-7592	4 15/16" X 1 1/2"	flat vase cap/flat vase cap
794-7092	4 15/16" X 2 9/16"	deep vase cap/flat vase cap
709-7092	5" X 1 13/16"	flat vase cap/flat vase cap
7092-718	5" X 1 11/16"	flat vase cap/vase cap
759-709	5" X 1 5/8"	flat vase cap/flat vase cap
759-718	5" X 1 7/8"	flat vase cap/vase cap
729-709	5" X 2"	vase cap/flat vase cap
734-718	5" X 2 1/4"	vase cap/vase cap
729-734	5" X 2 1/4"	vase cap/vase cap
707-711	5 1/4" X 2 1/2"	canopy/canopy
755-712	5 1/4" X 2 15/16"	flat vase cap/half ball
701-712	5 1/4" X 3 1/2"	canopy/half ball
702-712	5 1/4" X 3 9/16"	embossed canopy/half ball
710-712	5 1/4" X 3 9/16"	embossed canopy/half ball
730-712	5 1/4" X 3 5/8"	vase cap/half ball
750-712	5 1/4" X 4"	vase cap/half ball
804-805	6 3/16" X 2 1/16"	canopy/canopy
60 REN	6 1/2" X 3/4" X 3/4"	wireway channel

***This is a partial listing of available fount sets, others are available.
Please look through other catalog sections for possible matches
or place a request based on size, shape, or your specific requirements.***

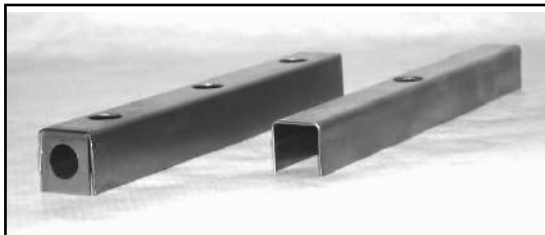

60 REN

6 1/2" X 3/4" X 3/4"

Standard with holes, available without

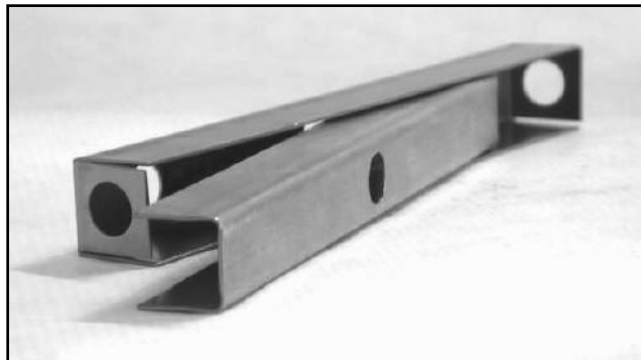

FOUNTS



A11-112
 1 9/16" OD
 1 3/16" high



A20C-TI-112
 1 9/16" OD
 13/16" high



112-112
 1 1/2" OD X 1 1/2" high

212-212
 2 1/16" OD X 2 1/16" high
 Standard 20ga

Both require welding



Shown in polished brass

A21-A22
 1 3/4" OD
 15/16" high

Same look top and bottom



Shown in polished brass

A22-A18
 1 3/4" OD
 1 7/16" high



182-212
 2 1/16" OD
 1 9/16" high

212 standard in 20ga

FOUNTS

1811-212
2 1/16" OD
1 3/8" high



190-191
2 1/16" OD
1 3/8" high

Standard 20ga

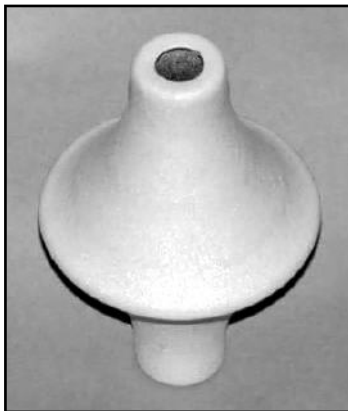

230-231
2 5/16" OD
3 7/8" high

Part shown
powder coated white



A31-A32
2 3/8" OD
1 3/8" high

Same look top and bottom



313-3142
2 5/16" OD X 2 5/8" high

412-4122
3 1/8" OD X 3 1/8" high

612-6122
4 3/8" OD X 3 1/2" high

364-313
2 3/8" OD
2" high

464-412
3 3/16" OD
2 1/4" high

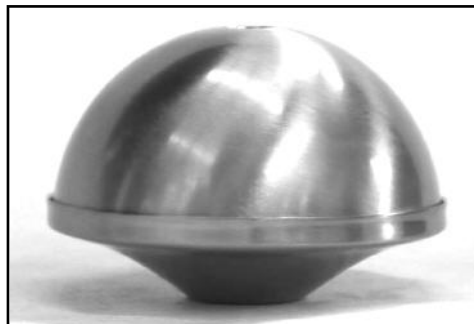

FOUNTS



313-314

2 3/8" OD X 2 5/16" high

412-413

3 3/16" OD X 3 1/18" high

612-613

4 7/16" OD X 4 3/8" high



A40-A41

2 13/16" OD X 1 5/8" high

Same look top and bottom



490-48511

3" OD X 3 1/8" high



485-458

3" OD X 2 3/8" high



FOUNTS

482-483
3 1/16" OD
1 1/16" high

top

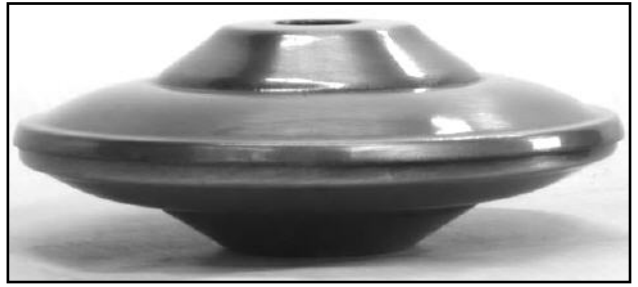

bottom





483-485
3 1/16" OD
1 1/16" high

top



bottom





484-485
3 1/16" OD
1 1/16" high

top



bottom





483-48511
3 1/16" OD
1 1/4" high

top



bottom



Fount sets can be made from matching parts or they can be made from interchangeable vase caps, canopies, and cups. Need something special or specific, please send print or sample for quote.

FOUNTS



48511-5386

3 1/8" OD

1 9/16" high

Same look top and bottom



484-413

3 3/16" OD X 2 1/4" high



558CI-3L-558

3 3/16" OD X 1 3/8" high



558CI-3L-540

3 3/16" OD X 1 3/8" high

FOUNTS

518-519
3 7/16" OD
1 1/4" high

Same look top and bottom



567-518
3 1/2" OD X 1 1/4" high



A57-3L-518D
3 1/2" OD X 1" high

520-521
3 9/16" OD X 1 5/8" high

630-631
4 7/16" OD X 1 7/8" high

729-734
5" OD X 2 1/4" high

Same look top and bottom



FOUNTS



580-581
3 9/16" OD
2" high

Same look top and bottom

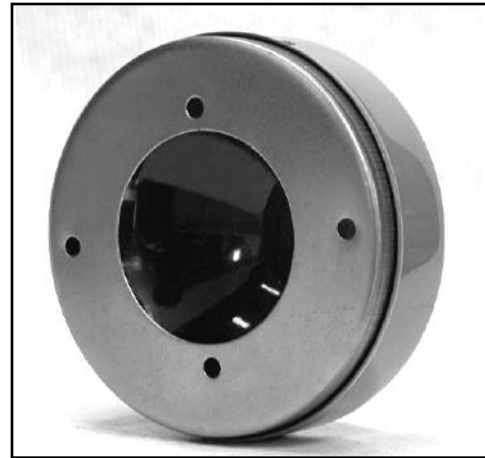

6454-640-20
4 3/8" OD X 1 7/8" high



608-609
4 7/16" OD
2 1/8" high

Same look
top and bottom

Shown with 6BL

FOUNTS

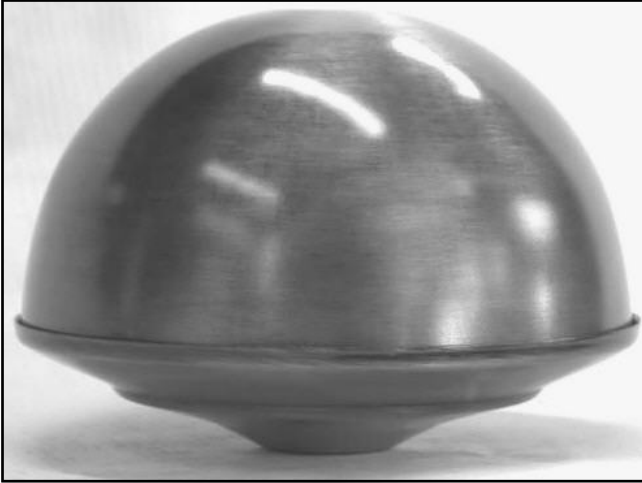

631-612
4 7/16" OD X 3 3/16" high



730-712
5 1/4" OD X 3 5/8" high



759-7592
4 15/16" OD
1 1/2" high



794-7092
4 15/16" OD
2 9/16" high



FOUNTS



709-7092
5" OD
1 13/16" high

Same look
top and bottom



7092-718
5" OD
1 11/16" high

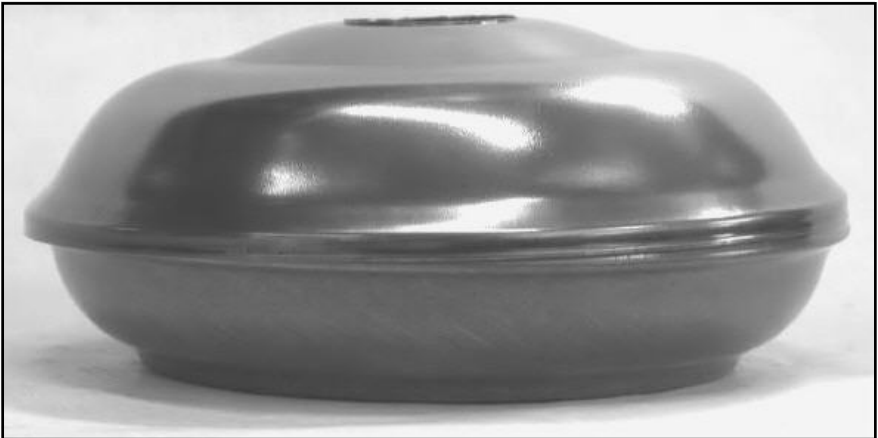

707-711
5 1/4" OD
2 1/2" high

FOUNTS

759-709
5" OD
1 5/8" high

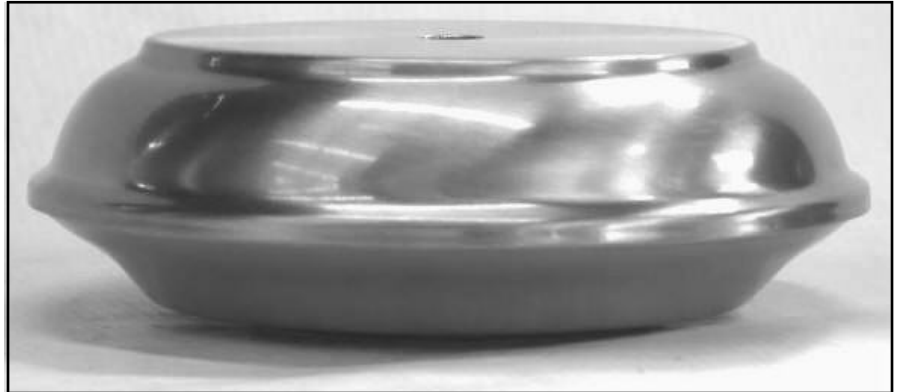

734-718
5" OD
2 1/4" high



FOUNTS



755-712
5 1/4" OD
2 15/16" high



750-712
5 1/4" OD
4" high



L
A
M
P

B
A
S
E
S

HOSPITALITY

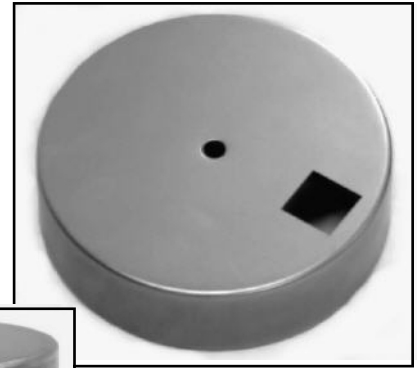

FLAT



CANDLESTICK



DECORATIVE

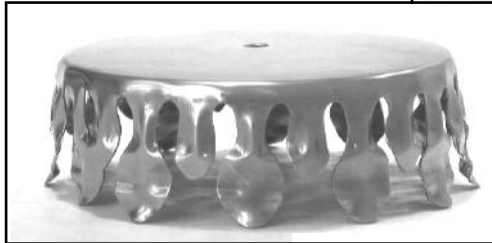

DEEP RECESSED



RECESSED



FLOOR LAMP

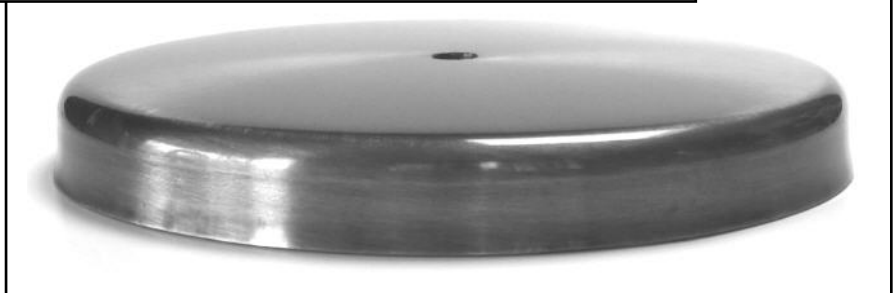

HOSPITALITY BASES



Part No.	O.D.	Height
7915-F	5 1/2"	1 1/2"
8005-F	6 1/8"	1 1/2"
8985-F	6 9/16"	1 1/2"
920-F	7 1/8"	1 7/8"
950-F	7 1/8"	1 1/2"
1050-F	8 1/8"	1 1/2"

Standard with .406 center hole for 1/8 pipe
Standard with felt flange

Standard Part Variations:
Add the following to part number for specifications,

- F felt flange
- C cord hole
- DP data port
- CO convenience outlet
- TOP CO convenience outlet on top
- SSW side switch hole - opposite cord hole
- SW switch hole on top
- ROCK rocker switch
- TOP ROCK rocker switch on top
- ROCK(B) button rocker switch
- O/S off set hole
- 9 9/16" center hole

**CUSTOM HOLE PATTERNS AND
VARIATIONS AVAILABLE UPON REQUEST**

FLAT LAMP BASES

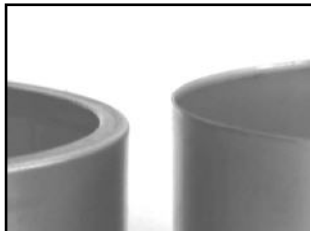

Lamp bases come standard with felt flange, (shown on the left).

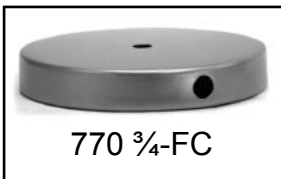
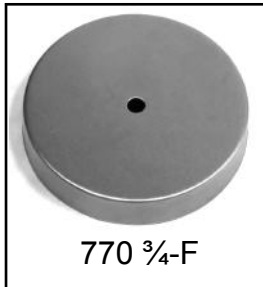

Part No.	O.D.	Height
526-F	3 7/16"	1"
A69-22-F	4"	1"
A60-F	4 3/8"	1"
A62-22-F	4 3/8"	3/4"
770 3/4-F	5 1/8"	3/4"
770-F	5 1/8"	1"
7705-24-F	5 1/8"	1 1/2"
791-F	5 1/2"	1 1/4"
7915-F	5 1/2"	1 1/2"
807 3/4-F	6 1/8"	3/4"
807-F	6 1/8"	1"
898 3/4-F	6 9/16"	3/4"
898-F	6 9/16"	1"
903-F	7 1/8"	7/8"
920-F	7 1/8"	1 7/8"
922-F	7 1/8"	1 1/16"
925-F	7 1/4"	1 1/8"
1003 3/4-F	8 1/8"	3/4"
1003-F	8 1/8"	1"
1101-F	9 1/8"	1"

Standard with .406 center hole to slip 1/8 pipe
Standard with felt flange

Standard Part Variations:
Add the following for part specifications,

- NCH no center hole
- C cord hole
- R outside rolled edge-available on select bases
- NL nite lite hole
- O/S off set hole
- SW switch hole on top
- SSW switch hole on side opposite cord hole
- 9 9/16" center hole
- TOP CO convenience outlet on top
- TOP ROCK rocker switch on top

CANDLESTICK BASES



A44-F
 3 1/16" OD
 3/4" high



518-F
 3 5/8" OD
 15/16" high



523-F
 3 1/2" OD
 3/4" high



750-F
 5 1/4" OD
 1 3/8" high



780-F
 5 1/8" OD
 1 1/4" high



830-F
 6 1/8" OD
 1 5/8" high

LAMP BASES

609-F
4 5/16" OD
1 1/8" high
3 13/32" across top



610-F
4 5/16" OD
1 3/8" high

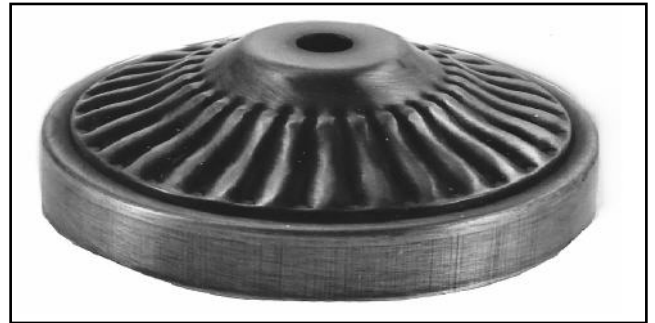

616
4 1/8" OD
3/4" high
3" across top

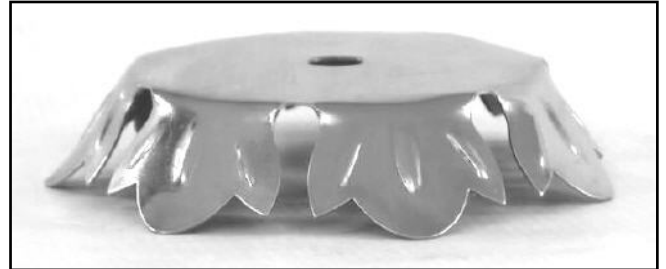

617
4 5/16" OD
1 3/8" high
3 7/8" across top

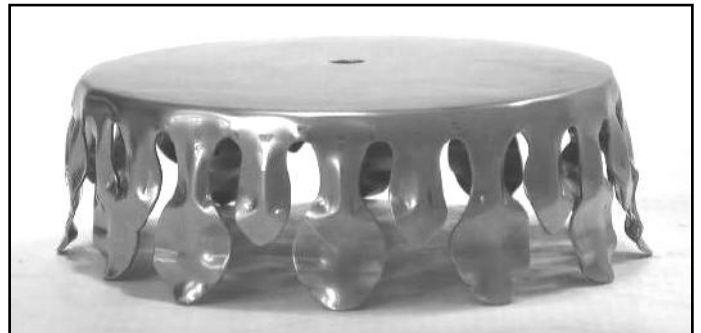
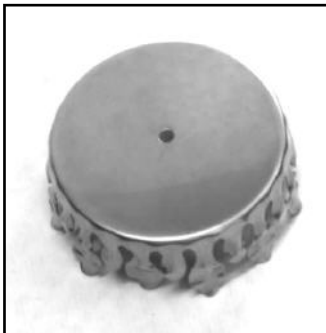

698-F
4 5/16" OD
1 1/8" high
3 3/8" recess



Bases come standard with felt flange.
Add -C to part number for a cord hole.
Additional holes available upon request.

LAMP BASES

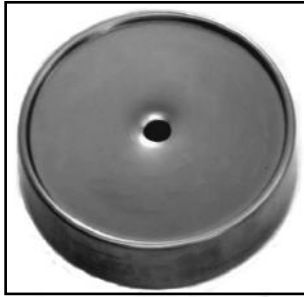

699-F
 4 5/16" OD
 1" high
 4" recess



764-F
 5 1/8" OD
 5/8" high
 4 7/16" across top



774-F
 5 1/18" OD
 1 5/32" high
 4" recess



777-F
 5 1/8" OD
 1 3/8" high

778-F
 5 1/8" OD
 1 3/16" high

3 1/4", 4", 4 3/8"
 recesses













790-F
 5 1/2" OD
 1 9/16" high
 3 15/16"
 across top



796-F
 5 5/8" OD
 1 1/16" high
 4 5/8" across top

7964-F
 5 5/8" OD
 1 1/16" high
 4" recess
 as shown in
 picture

LAMP BASES

<p>797-F 5 5/8" OD 1 3/8" high 4" recess</p>		
<p>7973-F 5 5/8" OD 1 3/8" high 3 3/4" deep recess</p>		
<p>7974-F 5 5/8" OD 1 3/8" high 3 13/32" across top</p>		 <p>Shown no center hole- 7974-F-NCH</p>
<p>798-F 5 5/8" OD 1 1/4" high 4 1/4" recess</p>		
<p>799-F 5 1/2" OD 1 1/4" high 5" recess</p>		

LAMP BASES

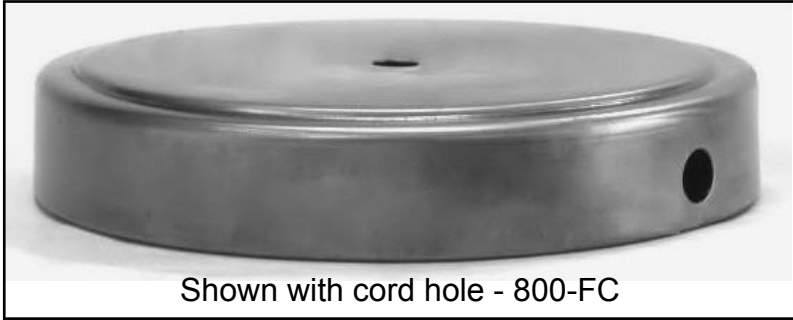

Shown with cord hole - 800-FC

800-F

6 1/8" OD 1" high
5 3/8" across top



810-F

6 1/8" OD 2 1/8" high
1 3/4" at top

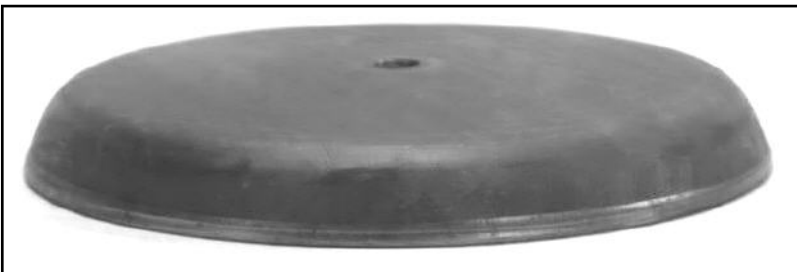

811

6 1/8" OD 3/4" high
11ga - straight only

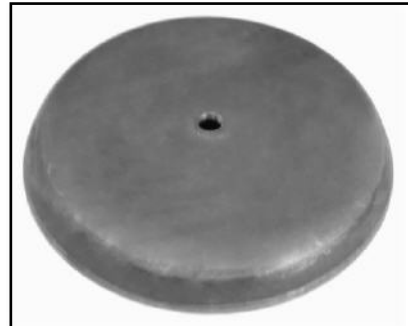

824-F

6 1/8" OD
4 1/2" recess

825-F

1 9/16" high
5" recess



Straight side
PN 8241
PN 8251



LAMP BASES

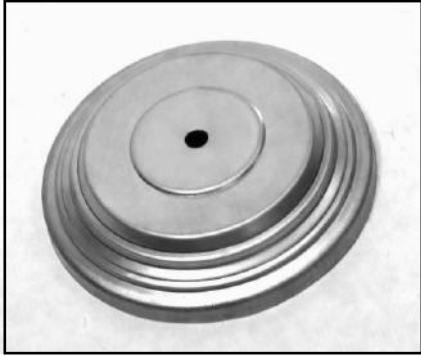

Shown with cord hole - 867-FC

867-F

6 1/8" OD 1 1/4" high
2 1/4" top step 4 1/8" across top

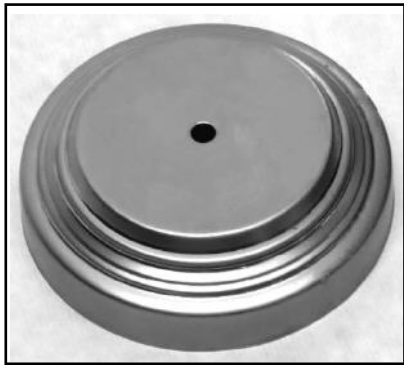

890-F

6 1/8" OD 1 5/8" high
4 1/8" across top



892-F

6 1/8" OD 1 1/4" high
4 15/16" across top

Shown in polished brass

894-F
6 1/8" OD
1 1/2" high
4" recess



LAMP BASES



897-F
6 9/16" OD 1 5/16" high
5 3/8" across top



8975-18-F
6 9/16" OD 1 7/16" high
Standard 18ga



899-F
6 9/16" OD 1" high
6" recess



LAMP BASES

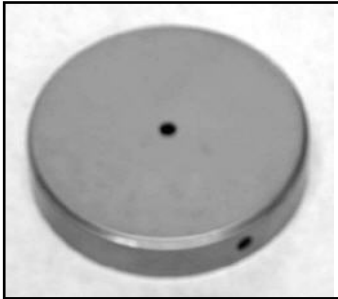

Shown with side switch hole - 900-F-SSW

900-F
7 1/8" OD 1 7/16" high
6 3/4" across top



904-F
7 1/8" OD 1 9/16" high
6" recess



905-F
7 1/8" OD 2" high
5" recess

LAMP BASES

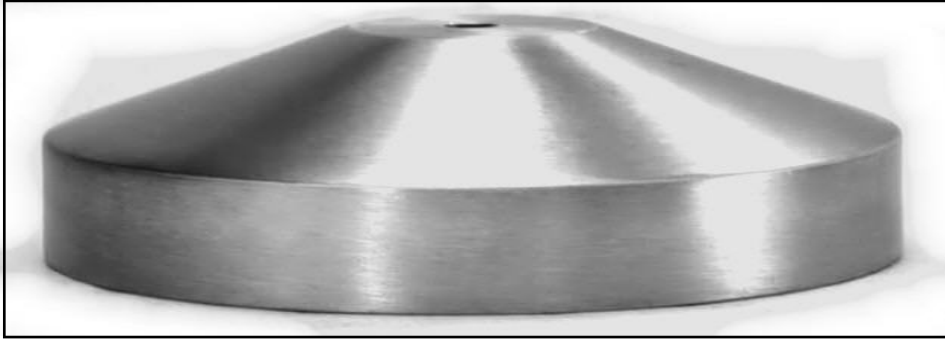

910-F
7 1/8" OD 2 1/8" high
1 3/4" across top



913-F
7 1/8" OD 1 1/2" high
4 1/4" recess
Also available without recess - flat 6" across top



921-F
7 1/4" OD 1 5/8" high
3" across top

LAMP BASES

926-F
7 1/8" OD
1 7/16" high
4" & 5" recesses

Shown antique brass finish

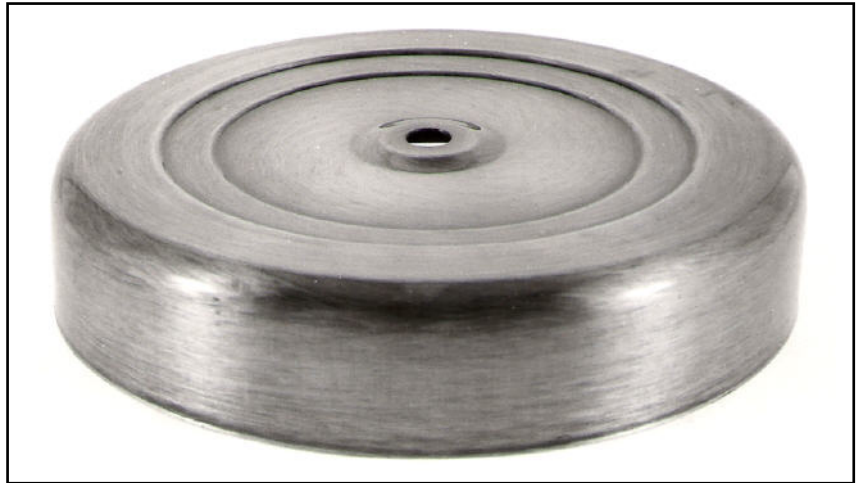

941-F
7 1/8" OD
1 1/2" high
6" recess

Shown antique brass finish

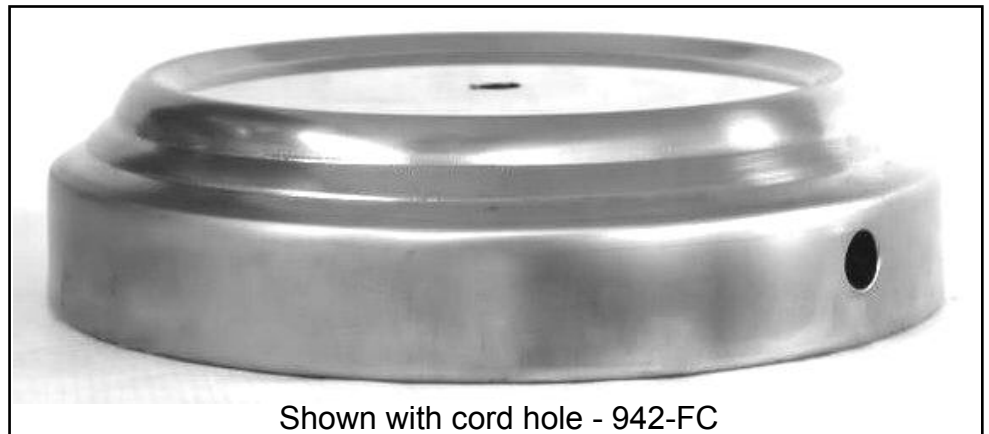

Shown with cord hole - 942-FC

942-F
7 1/8" OD 2" high
4 3/8" recess

LAMP BASES

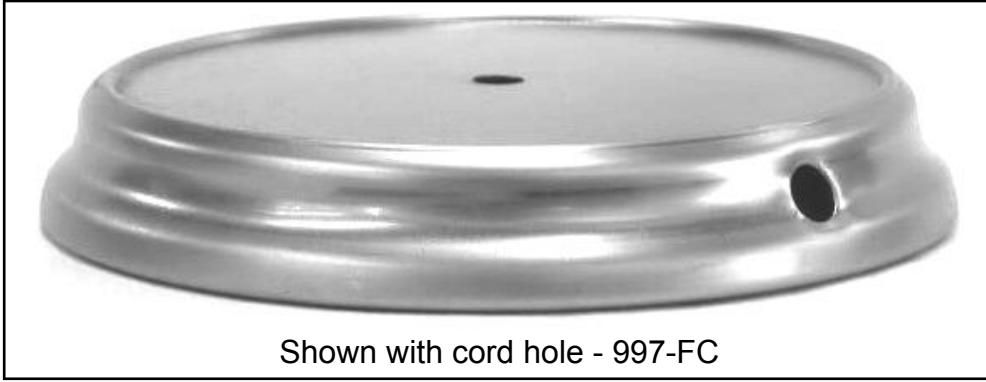

Shown with cord hole - 997-FC

997-F

7 1/8" OD 1" high

6" recess

Standard in 22ga



1004-F

8 1/8" OD 1 1/2" high

5 1/2" & 6" recesses



1005-F

7 1/8" OD 2" HIGH

6 1/2" recess



LAMP BASES



1027-F
8 1/8" OD 1 1/4" high
7 1/8" across flat

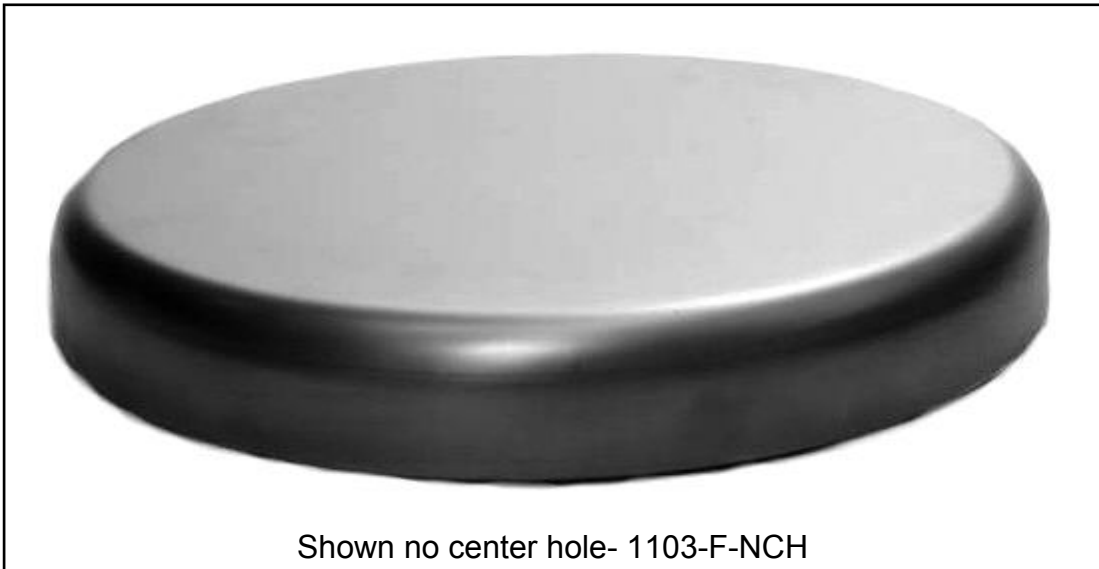

Shown no center hole- 1103-F-NCH



1103-F
9 1/8" OD
1 1/8" high

Available in pre-plated steel

Lamp Bases come standard with the turned in felt flange; all can be ordered straight and some are available with a rolled edge. Many hole options are available, including: cord hole, offset hole, switch hole, nite lite hole, convenience outlet hole, data port hole, rocker switch hole, and various size center holes. Along with standard hole options, custom hole pattern requests are welcome.

FLOOR LAMP BASES

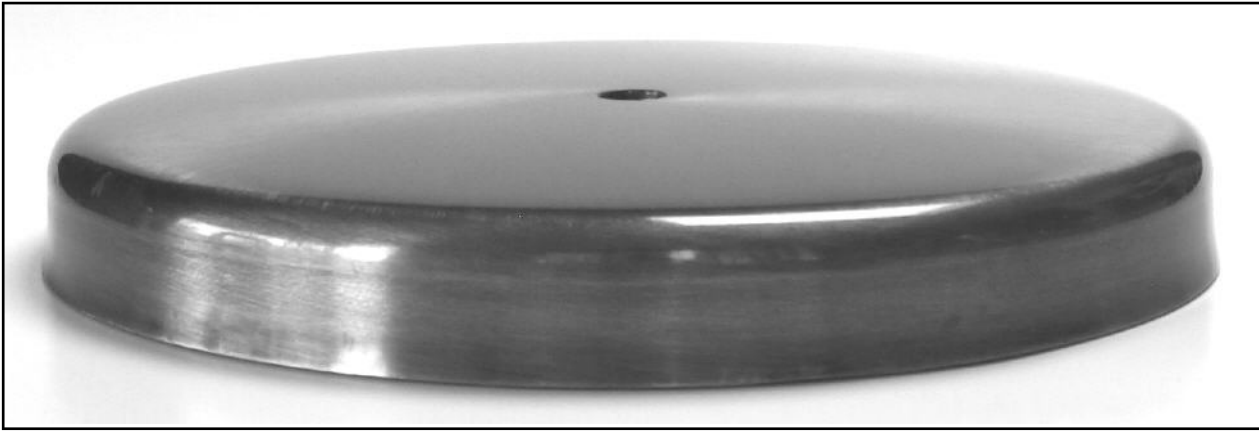

1200-9
11ga

1216-9
16ga

1218-9
18ga

1220-9
20ga

1222-9
22ga

10" OD
1 1/16" high
Standard with 9/16" center hole
Felt flange available on 1222-9

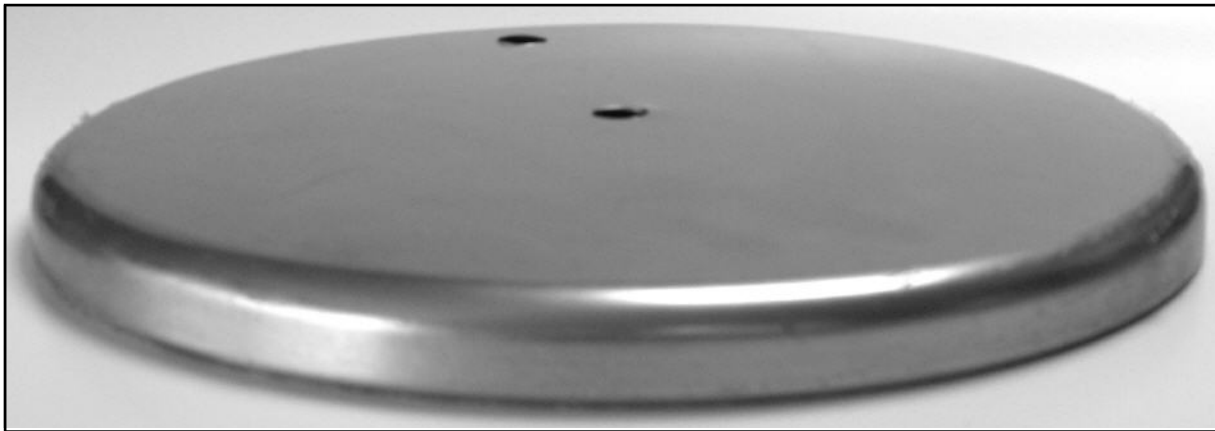

Shown with center hole and offset hole

1303-9
11" OD
1 1/16" straight height
7/8" high with felt flange - order -F
Standard with 9/16" hole
Specify 24 or 22ga
Available in pre-plated steel



FLOOR LAMP BASES

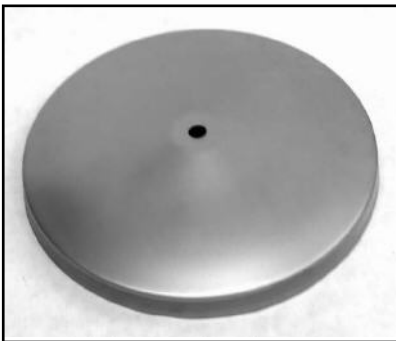

1300-9
14ga

1300-16-9
16ga

11" OD
2" high tapered base
Standard with 9/16" center hole

Can be ordered with tapped center hole

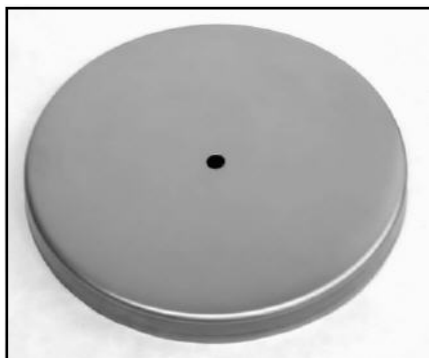

1301-9
14ga

1316-9
16ga

11" OD
1 1/16" high
Standard with 9/16" center hole

Can be ordered with
tapped center hole or offset hole

DISPLAY STAND BASES



Hat Stand Display Base



648-3-18
4" OD
1 1/16" high
3/16" center hole
Standard 18 ga



811

6 1/8" OD 3/4" high

11ga - straight only

Available with tapped center hole

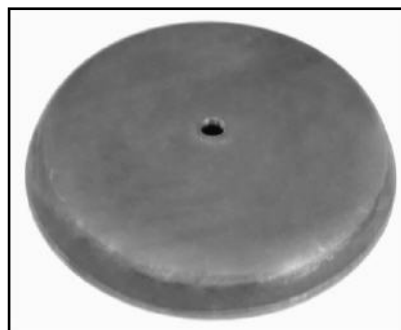

For other display base options, see regular bases

LAMP BASE HOLE PATTERN OPTIONS AND ORDERING CODES

-F	Felt flange - standard on most bases
-R	Outside rolled edge - available on select bases
-C	Cord hole (7/16")
-C(3/8)	3/8" cord hole - available on select bases
-NCH	No center hole
-O/S	Off set hole
-NL	Nite lite hole
-SW	Switch hole on top
-SSW	Switch hole on side opposite cord hole
-9	9/16" center hole
-CO	Convenience outlet on side
-TOP CO	Convenience outlet on top
-DP	Data port
-ROCK	Rocker switch
-TOP ROCK	Rocker switch on top
-ROCK(B)	Button rocker switch
-KEY	Key hole

Custom hole patterns and combination hole patterns available upon order.



LEAVES, ROSETTES, & RELATED PARTS



LEAVES, ROSETTES, & RELATED PARTS

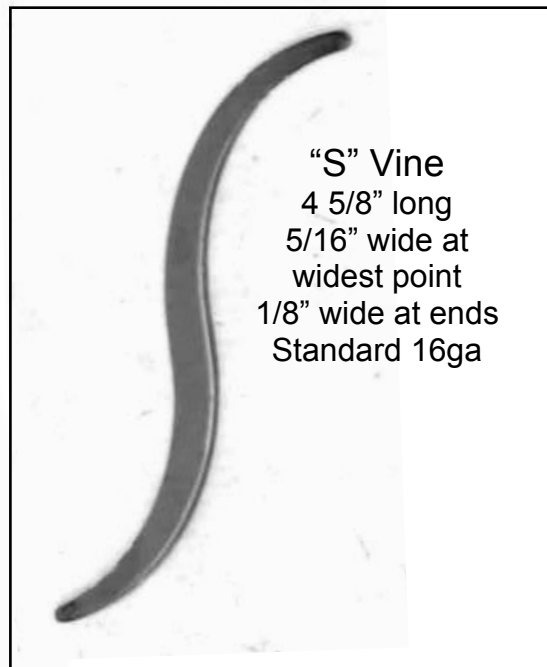
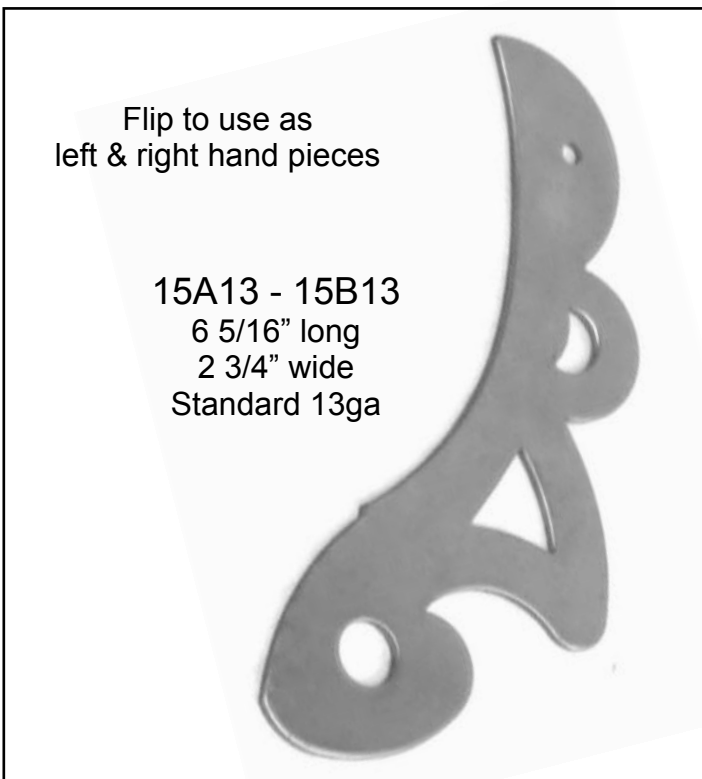
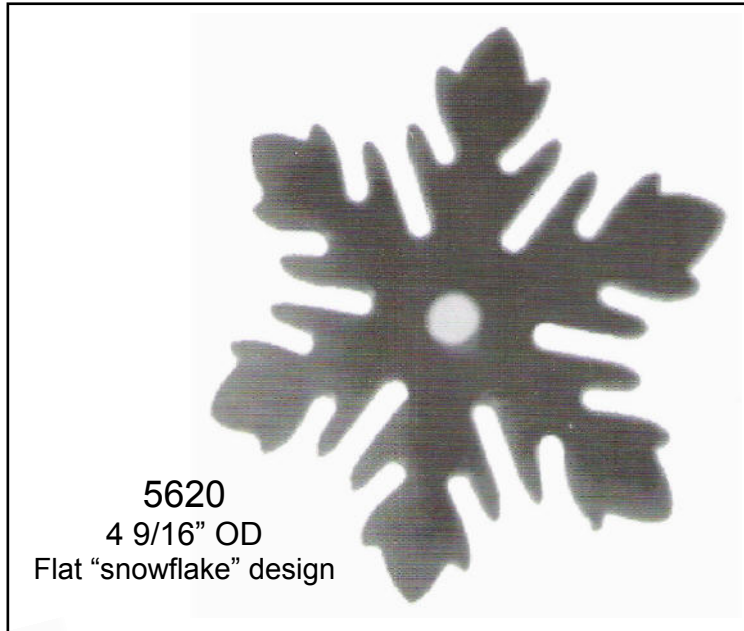
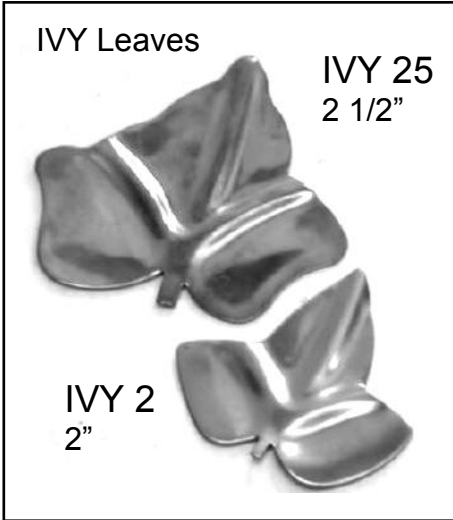
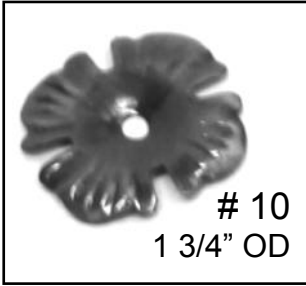

LEAVES, ROSETTES & DELTAED PARTS

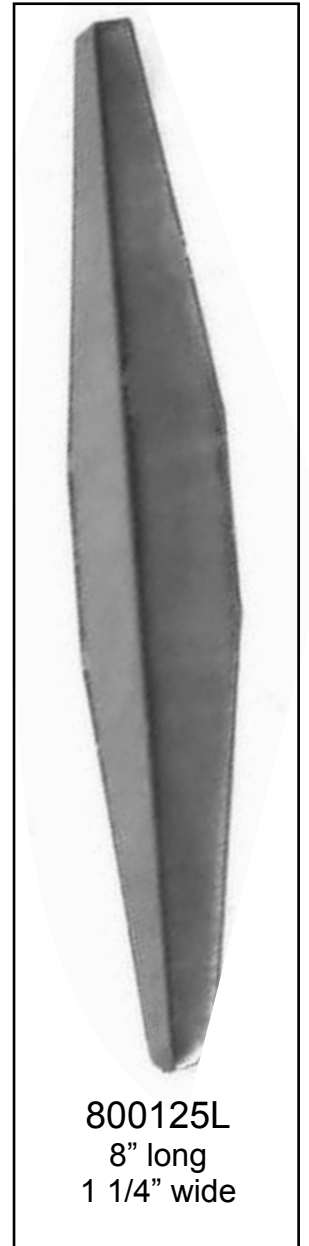
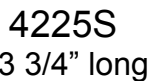
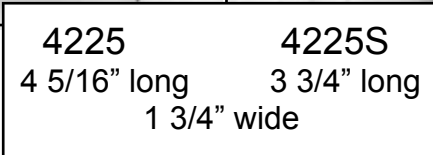
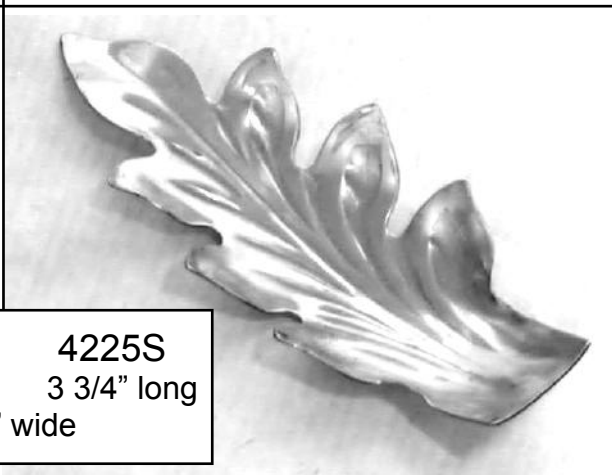
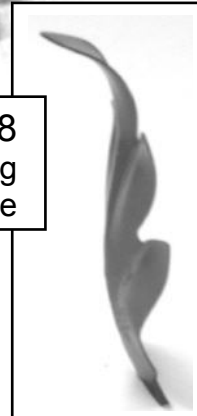
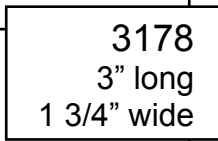
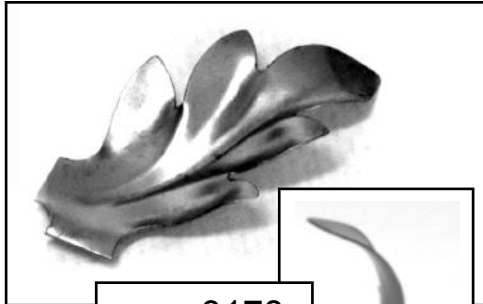
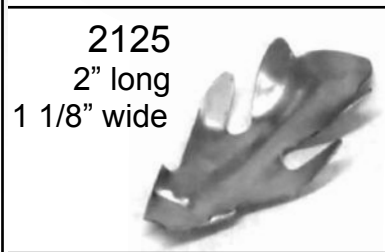
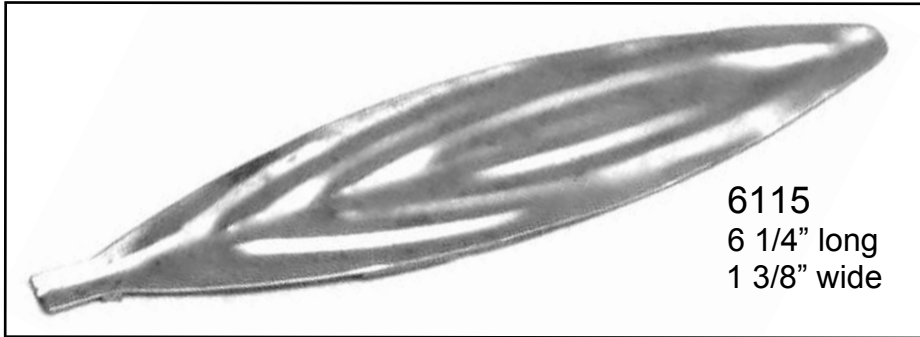
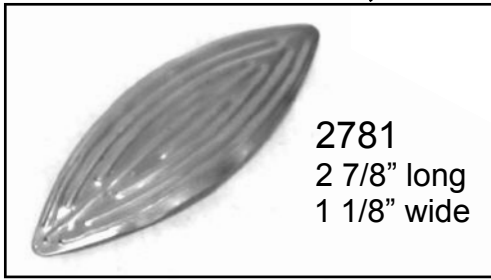

LEAVES, ROSETTES, & RELATED PARTS

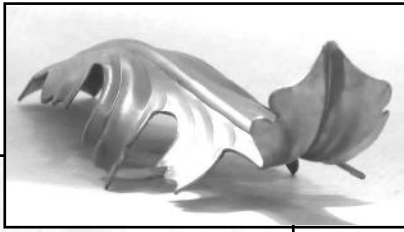

700275L
6 1/4" long
1 7/8" wide
Standard 20ga

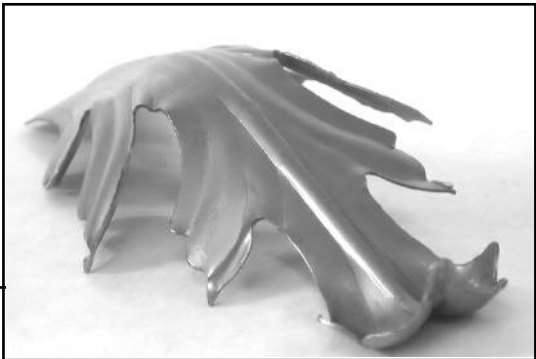
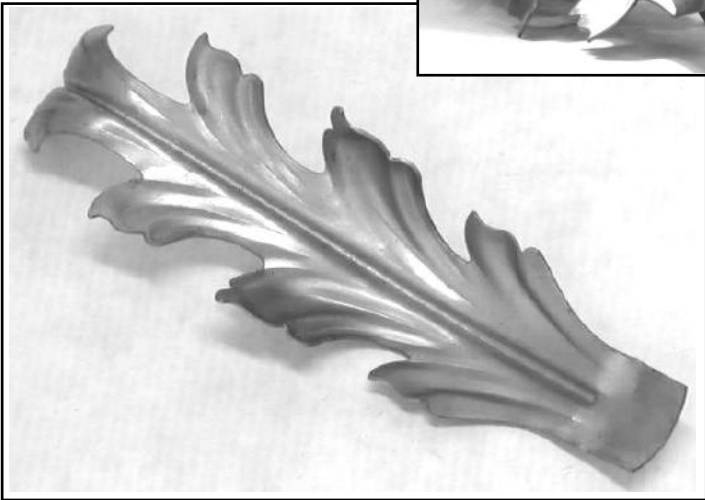

12005000L
10 1/2" long
3 1/2" wide
Standard 20ga

Available flat-
PN 1200500FL

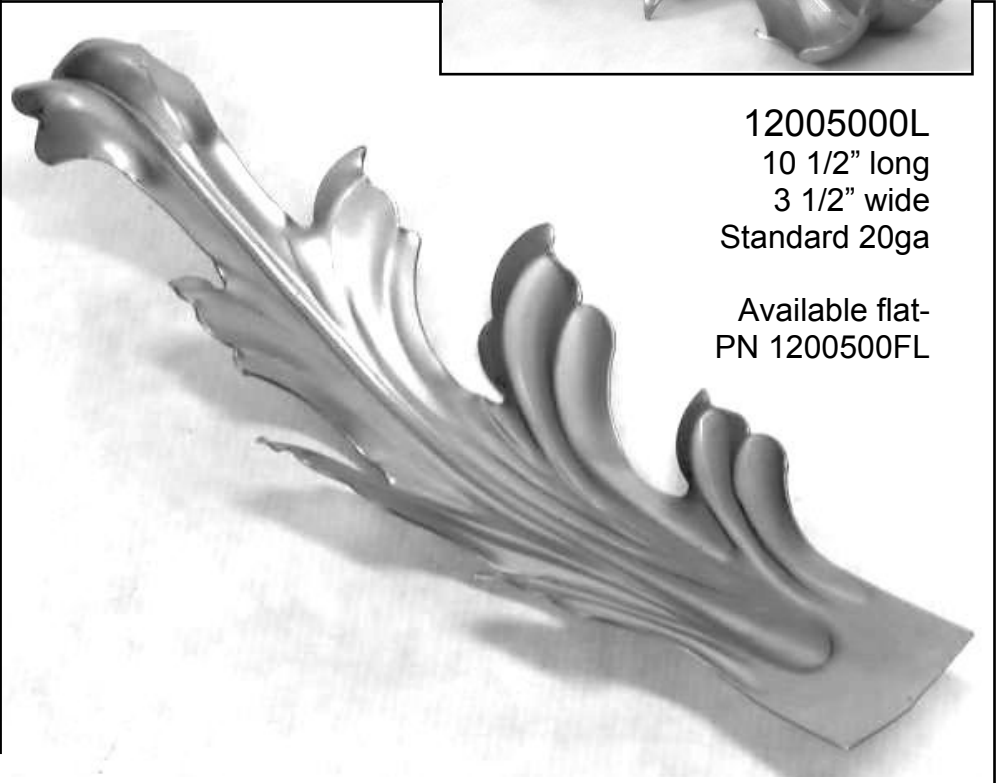

LEAVES, ROSETTES, & RELATED PARTS

5910
3" OD
1 1/8" high

Available with
prism holes
PN 5910-P

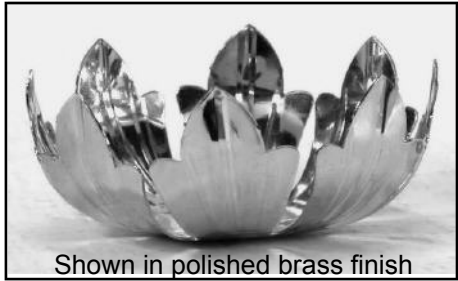

Shown in polished brass finish

5921
3 5/8" OD
1/2" high

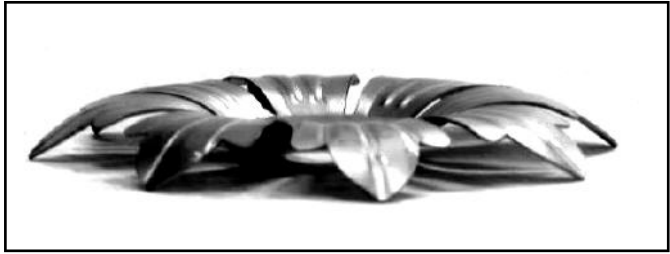

5911
3 3/4" OD
1 1/4" ID
1/2" high

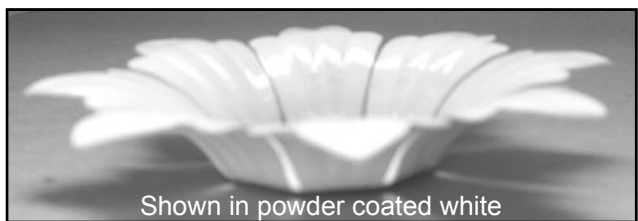

Shown in powder coated white

5922
3 3/4" OD
1 1/4" ID
7/8" high

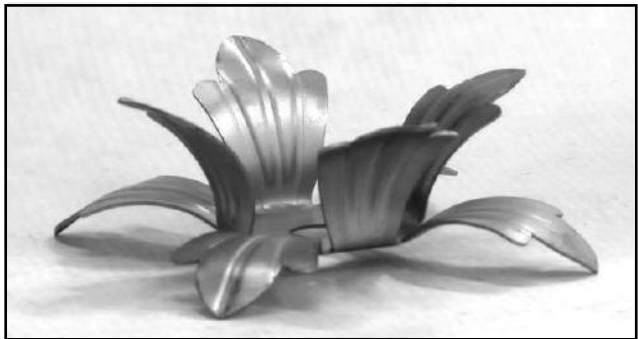
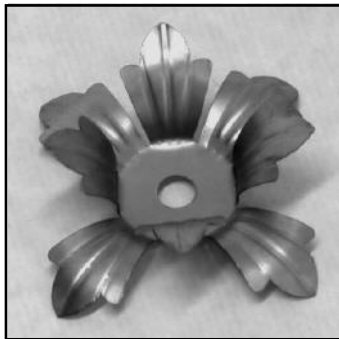

5622
4" OD
7/8" ID
1" high

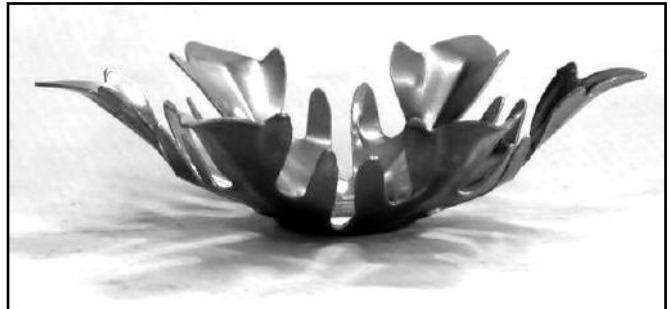

LEAVES, ROSETTES, & RELATED PARTS



Shown in bronze powdercoat finish

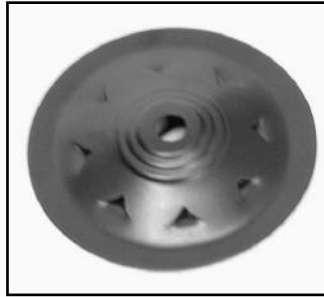

4001WRA-V-20
4" OD
1/2" high
3/8" flat flange
Standard with
slotted vents

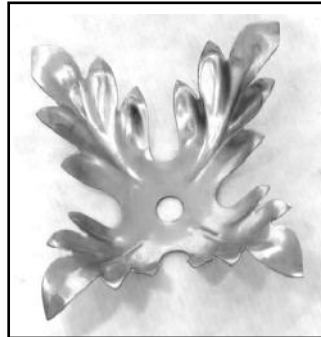

6421
6" OD tip to tip
4" petal to petal
1 1/2" ID
1 1/8" high



6422
4 1/2" OD tip to tip
3 1/8" petal to petal
2 1/8" ID
2" high



616
4 5/8" OD
3/4" high

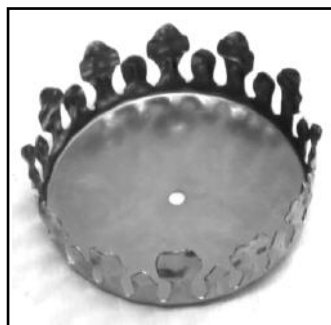

617
4 3/8" OD
1 3/8" high



V A S E C A P S



VASE CAPS



Part no.	ID	Height
320	2 5/16"	11/16"
36691	2 7/16"	11/16"
431	3 1/8"	11/16"
520	3 1/2"	7/8"
521	3 7/16"	7/8"
629	4 1/16"	15/16"
630	4 5/16"	1"
631	4 3/8"	1"
729	4 7/8"	1 1/16"
734	4 15/16"	1 5/16"
730	5 3/16"	1 1/8"
760	5 7/16"	1 1/8"
830 (deep)	6 1/16"	1 15/16"

Some variation in look and design,
See following pages for actual picture or request samples.



H476

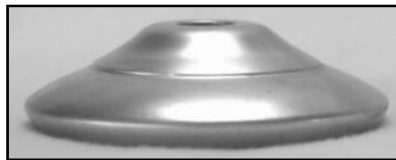

3669



4851 & 5386

CAPS WITH TURNED IN EDGE



535



536



490

VASE CAPS

<p>A11 1 1/2" ID 7/16" high</p>	<p>A21 1 3/4" ID 1/2" high A21-A22 fount set A21 fits A20 series cups</p>	<p>A22 1 5/8" ID 1/2" high</p>		
<p>181 2" ID 1/2" high Fits 180 series cups</p>				
<p>1811 2" ID 5/8" high Fits 180 series cups</p>				
<p>182 2" ID 11/16" high Fits 180 series cups</p>				
<p>A31 2 5/16" ID 11/16" high</p>	<p>A32 2 1/4" ID 3/4" high A31-A32 fount set A31 fits A30 series bodies/cups</p>			
<p>A33 2 1/4" ID 11/16" high</p>				
<p>320 2 5/16" ID 11/16" high Fits A30 series bodies/cups</p>				

Most vase caps come standard in 24 gauge steel.
For other gauges or hole variations, please call.

VASE CAPS



364
 2 5/16" ID
 11/16" high
 Fits A30 series bodies/cups



3669
 2 13/32" ID
 25/32" high
 Turned in edge



36691
 2 7/16" ID
 11/16" high



A40	A41
2 11/16" ID	2 3/4" ID
15/16" high	13/16" high
A40-A41 fount set	
A41 fits A46 series bodies/cups	



H40
 2 11/16" ID
 11/16" high
 1 1/8" recess



H476
 2 13/16" ID
 25/32" high
 Turned in edge
 Adjustable to fit A46 series bodies



H4761
 2 27/32" ID
 13/16" high



476
 2 13/16" ID
 11/16" high
 Fits A46 series bodies/cups

VASE CAPS

Q49
 2 15/16" ID
 1" high
 Available 20ga
 PN Q49-20



Q478
 2 15/16" ID
 3" OD
 1 1/8" high



482 483
 3" ID 3 1/16" ID
 5/8" high 9/16" high
 482-483 fount set
 482 fits A48 series
 bodies/cups



484 485
 3 1/16" ID 3" ID
 11/16" high 11/16" high
 484-485 fount set
 485 fits A48 series
 bodies/cups



4851
 2 13/16" OD
 13/16" high
 Turned in edge



48511
 3" ID
 13/16" high
 Fits A48 series
 bodies/cups



VASE CAPS



486
3" ID
7/8" high
Fits A48 series



490
3" ID
1 3/8" high
Diameter adjustable
from 3" to 3 1/8" ID
Fits A48 series



468
3 1/16" ID
3/4" high



480
3 1/16" ID
3/4" high



A44
3 1/8" ID
7/8" high
Fits 414 or 415 series



431
3 1/8" ID
1 1/16" high
Fits 414 or 415 series



464
3 1/8" ID
13/16" high
Fits 414 or 415 series

VASE CAPS

5386
 3 1/16" ID
 27/32" high
 Turned in edge



53861
 3 1/8" ID
 7/8" high



5411
 3 1/8" ID
 5/16" high

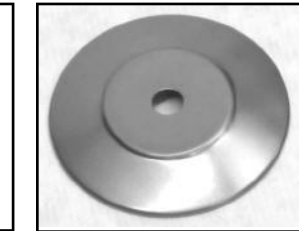

539
 3 5/32" ID
 15/16" high
 Standard with or
 without center hole



Shown no center hole- 539-NCH

540
 3 5/32" ID
 1 5/16" high



558
 3 5/32" ID
 1 5/16" high



VASE CAPS



518 519
 3 5/16" ID 3 3/8" ID
 3/4" high 3/4" high

Fits 516
 518-519 fount set



523
 3 7/16" ID
 7/8" high

Fits 516



567 568
 3 7/16" ID 3 9/16" ID
 5/8" high 3/4" high

567 fits 516
 568 fits A50 series



532
 3 3/8" ID
 1 7/16" high



509
 3 1/2" ID
 3/8" high

VASE CAPS



511
 3 1/2" ID
 11/16" high
 511 has a smaller lip

511D
 3 1/2" ID
 15/16" high



514
 3 1/2" ID
 1 1/8" high



520
 3 1/2" ID
 7/8" high
 520-521 fount set

521
 3 7/16" ID
 7/8" high
 521 fits 516

VASE CAPS



530
 3 1/2" ID
 15/16" high
 530-531 fount set



531
 3 7/16" ID
 15/16" high
 531 fits 516



A 51
 3 9/16" ID
 1 3/16" high
 A51 fits A50 series



Q52
 3 1/2" ID
 1 3/16" high
 A51-Q52 fount set



580
 3 1/2" ID
 1 1/16" high
 580-581 fount set



581
 3 7/16" ID
 1 1/16" high
 581 fits 516

VASE CAPS

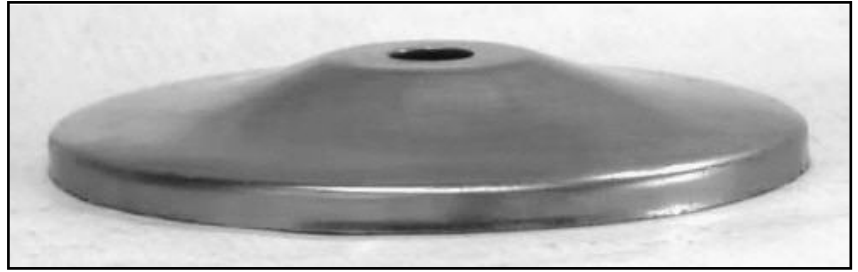

564
3 9/16" ID 7/8" high
Fits A50 series bodies/cups



Q56
4" ID 1" high



535
4 1/16" ID 1 3/16" high
Turned in edge
Diameter adjustable from 4 1/16" to 4 5/16" ID

VASE CAPS



536

4 1/16" ID 1 1/16" high
Turned in edge

Diameter adjustable from 4 1/16" to 4 5/16" ID
Fits A60 series bodies/cups



628

4 1/16" ID 1 3/16" high
Fits A69



629

4 1/16" ID 15/16" high
Fits A69

VASE CAPS



618
4 1/4" ID 1 5/16" high

619
4 3/16" ID 1 5/6" high
618-619 fount set



630
4 5/16" ID 1" high
630-631 fount set

631
4 3/8" ID 1" high
631 fits A60 series



634
4 5/16" ID 1 1/4" high

VASE CAPS

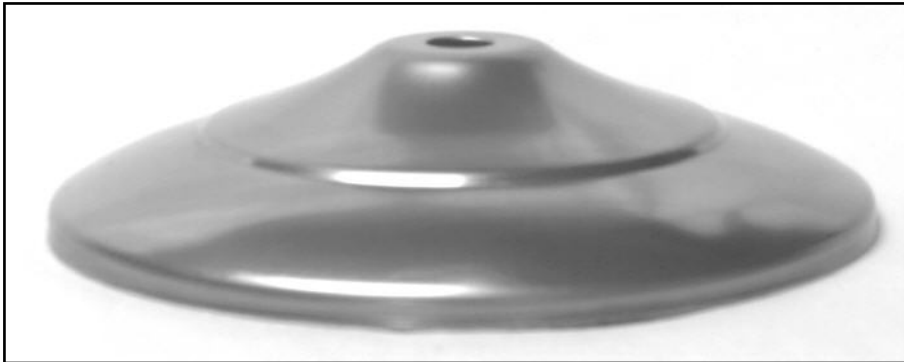

729
4 7/8" ID 1 1/16" high

7292
4 5/8" ID 1 1/16" high
Turned in edge
Diameter adjustable from 4 5/8" to 4 7/8" ID



759
4 7/8" ID 3/4" high

7592
4 3/4" ID 13/16" high
759-7592 fount set



794
4 7/8" ID 1 5/8" high

Shown polished brass finish

VASE CAPS

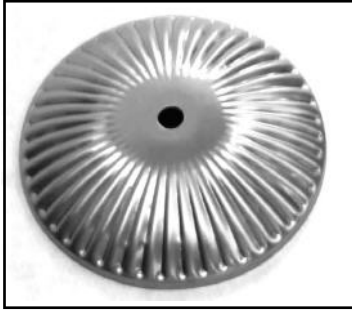

704
4 15/16" ID 15/16" high



709
4 15/16" ID 15/16" high

7092
4 7/8" ID 1" high
Turned in edge



714
4 15/16" ID 13/16" high

VASE CAPS



718
4 15/16" ID 1 1/4" high



719
4 15/16" ID 1 9/16" high

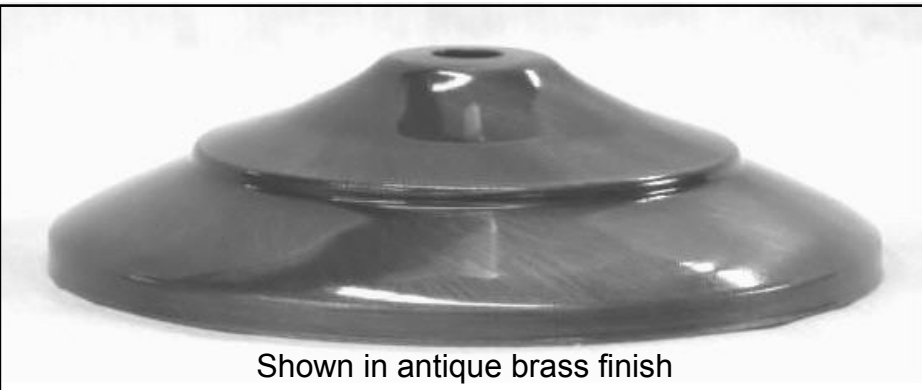

Shown in antique brass finish

734
4 15/16" ID 1 5/16" high

VASE CAPS



717

5 1/16" ID 1 5/16" high
Standard with .406 center hole
Standard 22ga



780

5 1/16" ID 1 1/2" high

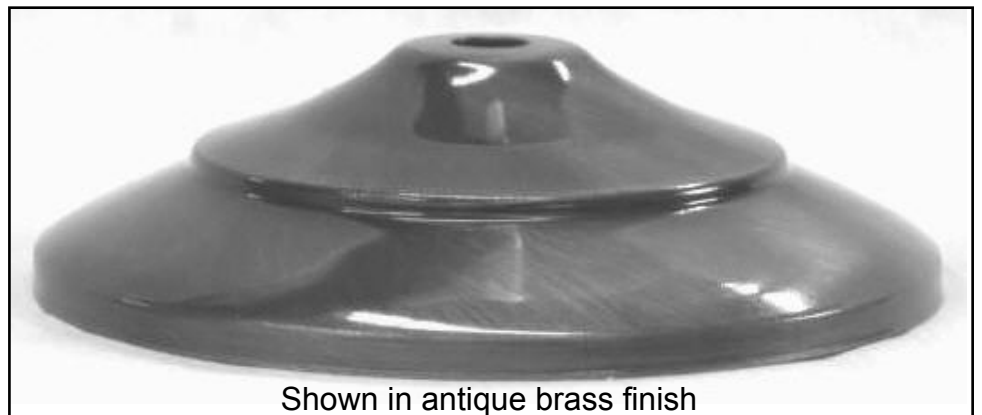

Shown in antique brass finish

730

5 3/16" ID 1 1/8" high
Standard 22ga

VASE CAPS



750
5 3/16" ID 1 5/8" high
Available 22ga, PN 750-22



755
5 3/16" ID 3/4" high
Available 22 ga, PN 755-22



716
5 3/16" ID 7/8" high

VASE CAPS

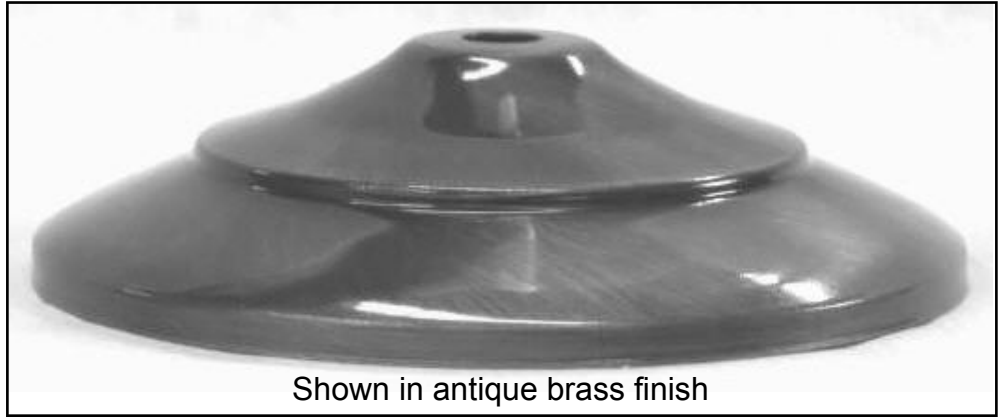

Shown in antique brass finish

760
5 7/16" ID 1 1/8" high

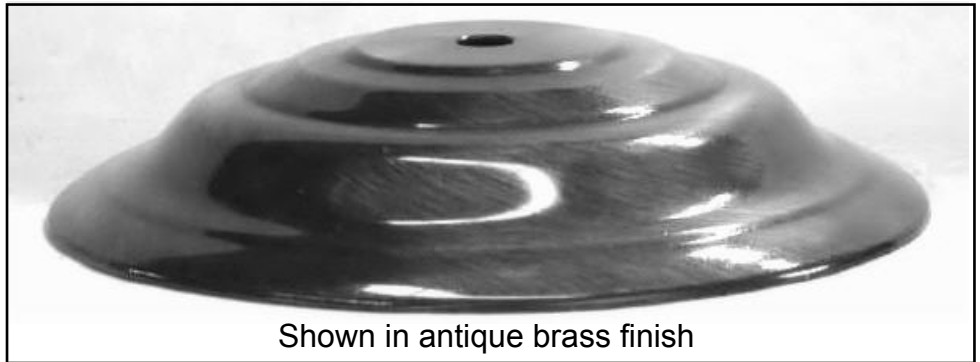

Shown in antique brass finish

850
6" ID 1 1/8" high
Available 22ga - PN 850-22

804
6 1/8" ID
1 5/16" high



VASE CAPS



805
6 1/8" ID
7/8" high
1 7/8" flat across top
Standard 24ga

Available 18ga - PN 805-18

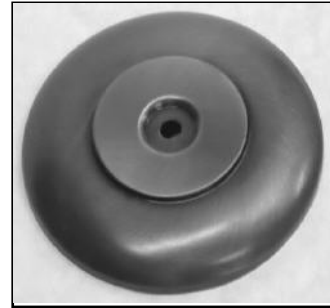

806
6 1/8" ID
1 3/8" high



VASE CAPS



830
6 1/16" ID
1 15/16" high

830D
6 1/16" ID
2 1/8" high

Standard 22ga
Lip is deeper on 830D



867
6 1/16" ID
1 13/32" high

VASE CAPS USED AS FOUNTS



A21-A22

Samples of vase caps that fit together as fount sets are shown on this page. See fount set section for a more complete showing.



482-483



518-519

Need a particular look or size, please provide print or sketch.

580-581



630-631



**A
D
D
I
T
I
O
N
A
L

P
A
R
T
S**



Plates and Washers

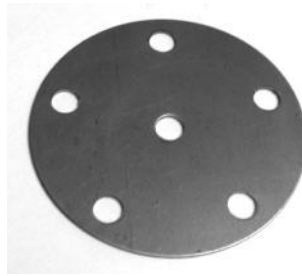

Shades & Shadeholders

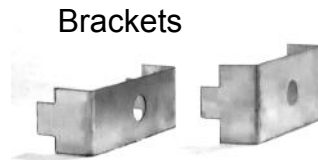

Brackets



Track Lites
Down Lites
Ceiling Collars
Porch Lites
Pin-up Lites

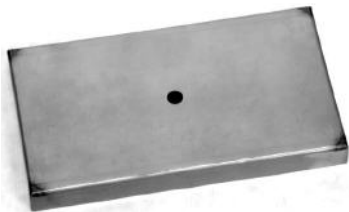

Rectangular & Square Pans



Switch Plates

RECESSED LIGHTING PARTS

Hangar bars



Recessed Can
Customer Owned

Plaster Frame

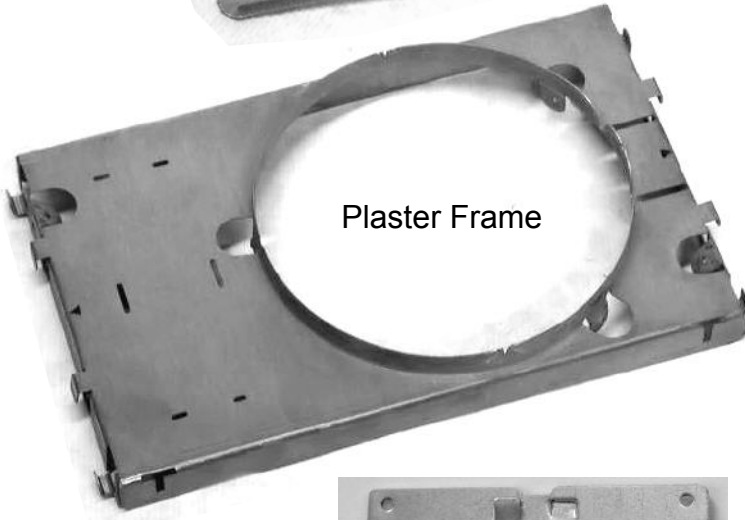

Retrofit Arm



J-Box Door

Call for information
on sizes, prices, &
availability

SAMPLES OF AVAILABLE CUSTOM WASHERS

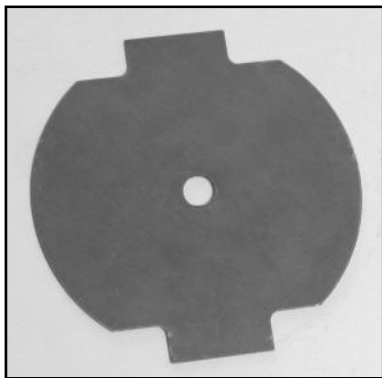

EARS 638
Bars - 4 1/4" OD
Round - 4 3/16" OD

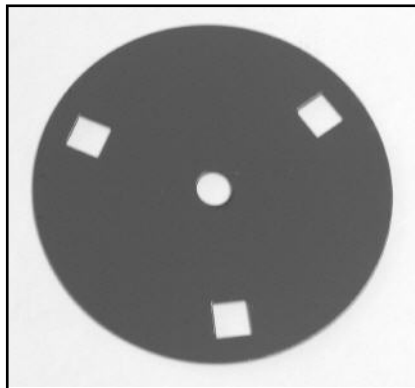

638-3SQL

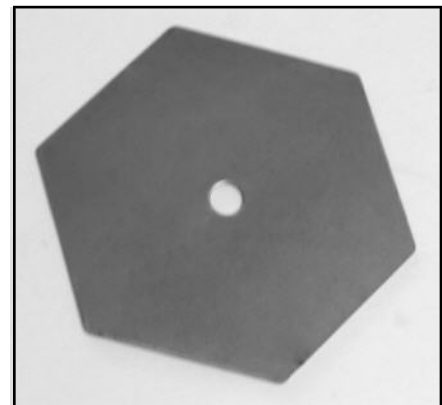

HEX 416
4 1/16" OD
each side 2 1/4" wide
Standard 16ga

PLATES / WASHERS

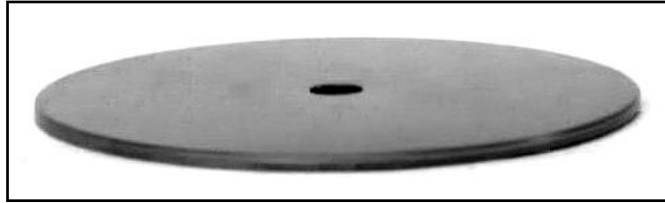

Part No.	O.D.	Part No.	O.D.
165	1 1/2"	6450	4 1/2"
279	2"	678	4 7/8"
479	2 1/4"	779	5"
365	2 1/2"	765	5 1/2"
478	3"	879	6"
325	3 1/4"	6500	6 1/2"
565	3 1/2"	8688	6 7/8"
5625	3.6"	979	7"
576	3 3/4"	1079	8 1/8"
637	4"	1179	9"
638	4 1/4"		

Most plates are stocked in 18ga,
many are stocked in 16ga and 11ga.
All are available by order from 11ga to 24ga.

Standard with .406 center hole to slip 1/8 pipe.
No center hole and other center hole sizes are available.
Bottom lite hole patterns are available from 1 hole to 12 holes.

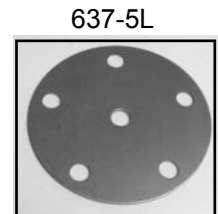
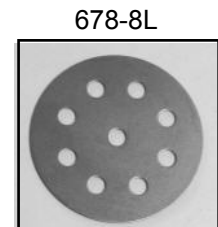
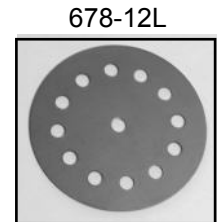

SQUARE PLATES

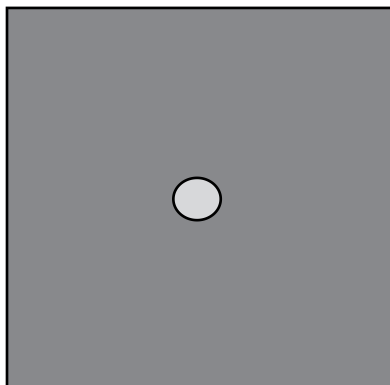

Line drawing

7433
4.33" Square
S45
4 1/2" Square
Available in various gauges

OVAL PLATE

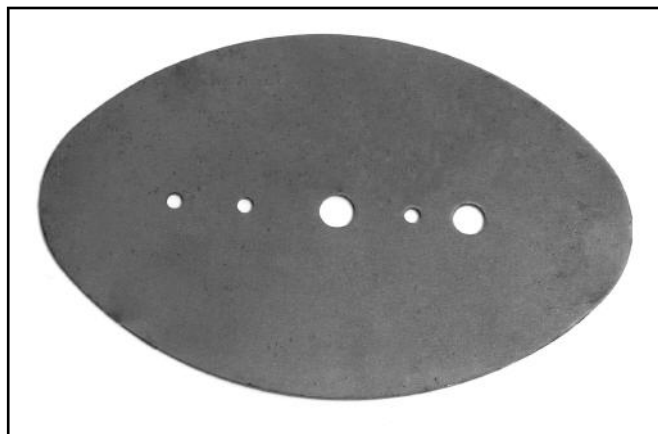

745-16
6 7/8" X 4 1/2"
Standard 16 ga
Available in various gauges
Shown with custom hole pattern

PRE-PLATED WASHERS

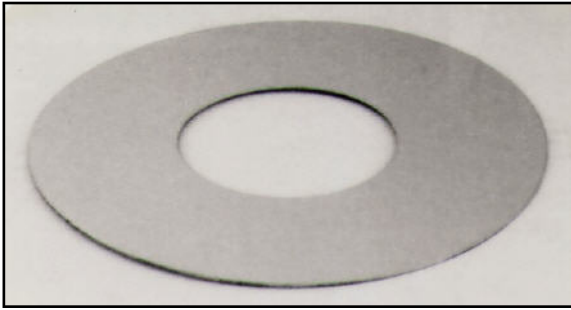

1 11/16" center hole
Used on Nord sockets

3 1/8" PP
3 1/2" PP
4" PP
6" PP

Standard in 025 preplated steel.
Available in bright brass,
bright chrome, and antique brass.
To order, state size and finish
Can also be run in
raw or galvanized steel
or other metals, specify when ordering.
Available in heavier gauges

LOCK WASHERS / SPECIALTY WASHERS



lock washer

AL WASHER
7/8" ID
1 1/16" OD at tab



C WASHER
1 1/2" OD
Slot is .41" Wide

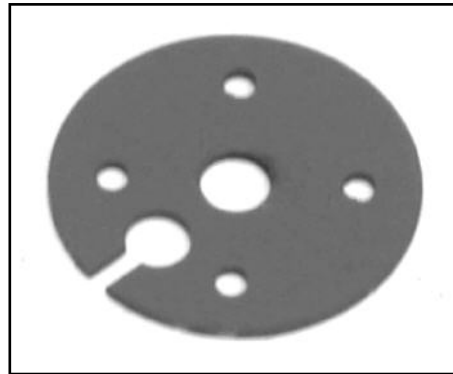

MG WASHER
2 1/4" OD

COLOR AND I.D. CHIPS



150
Round
1 1/2" OD
1/8" ID offset hole

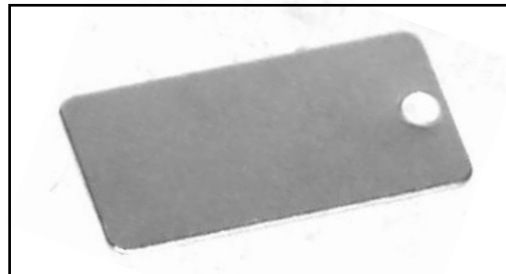

256X125
Rectangular
2.56" X 1.25"
3/16" ID offset hole

Both available without offset hole.
Available in various gauges and metals.

SHADES / SHADE HOLDERS

534
 3 15/16" OD
 3 1/2" ID
 1 1/8" high



6347
 4 1/4" OD
 3 9/16" ID
 1 1/8" HIGH



681
 4 3/4" OD
 3 7/16" ID
 9/16" high



5216
 5 1/2" OD
 3 5/16" ID
 5/8" high
 3 chain holes



761
 5 1/2" OD
 1 5/16" high
 3/4" center hole



7912-V-SL
 5 1/4" OD
 4 7/8" ID
 3 1/8" high
 Slotted vents
 Embossed side hole



SHADES / SHADE HOLDERS

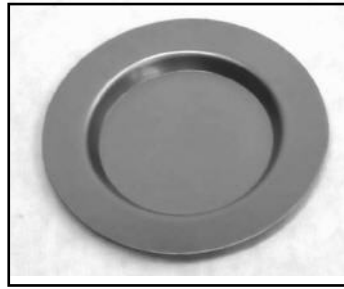

65151
6 7/8" OD
4" ID
3/8" high



861
7 1/8" OD
1 1/2" high
3/4" center hole

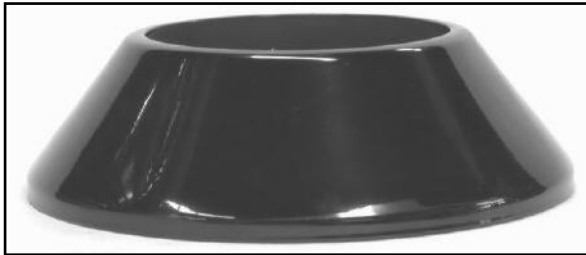

9104
7 1/8" OD
2 1/8" high
3 15/16" ID center hole



Shown in polished brass

998
7 1/8" OD
3 1/2" high
2" ID center hole
Available vented



9812
7 1/4" OD
6 1/16" ID
3 evenly spaced
1/4" holes on 1/2" flange
6 evenly spaced 13/32"
vent holes around center hole
Available without holes

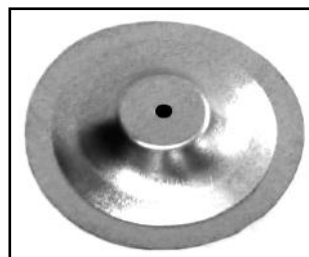
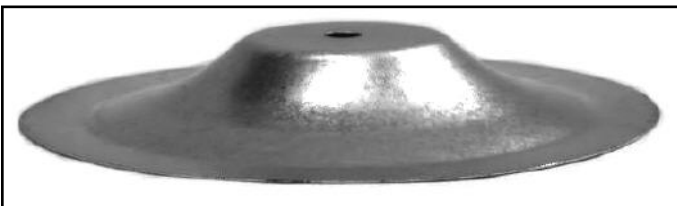

8161
7 5/8" OD
1" high
3/4" uneven
flange

SHADES / SHADE HOLDERS

816
 7 5/8" OD
 1" high
 1 3/4" center hole
 Available with .406
 center hole

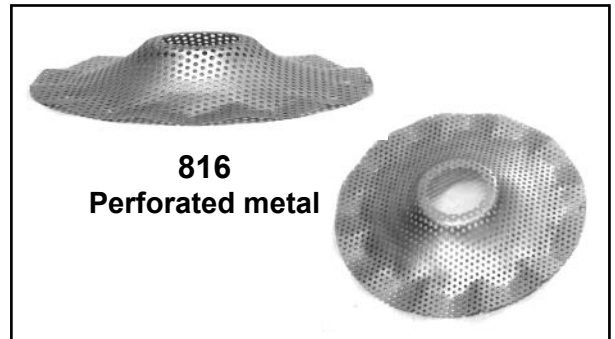
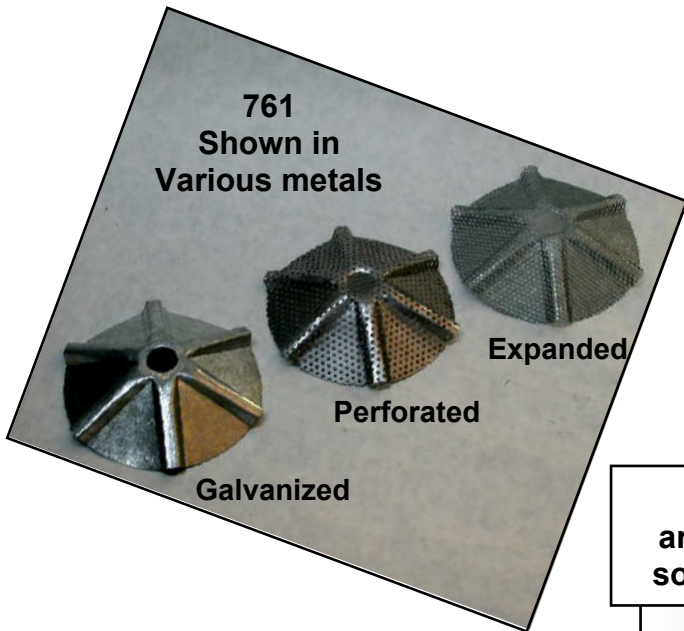
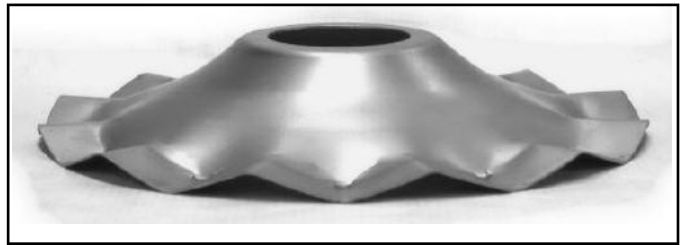

**Shades and shade holders
 are available in various metals
 some of which are shown here.**

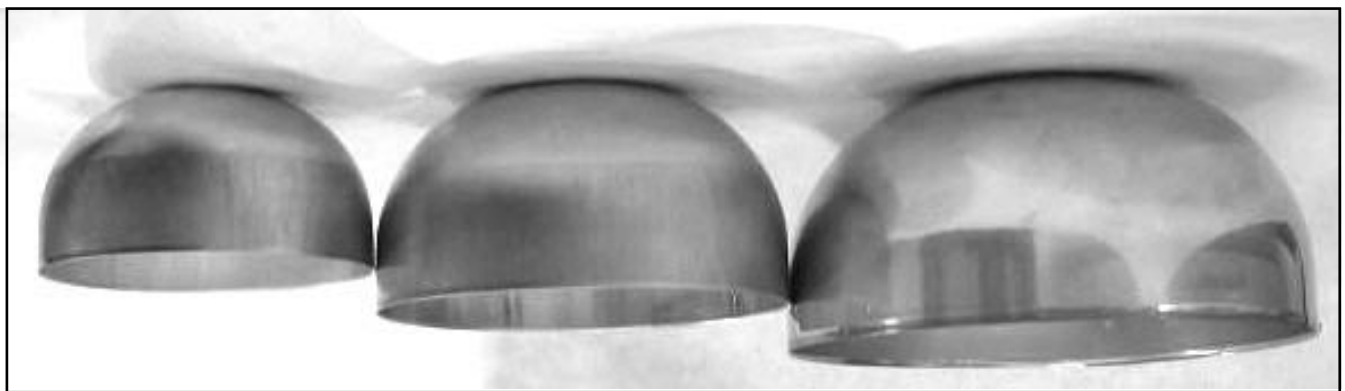

<p>6911 4 3/8" OD 2 1/4" high 1 1/2" flat</p>	<p>7911 5 1/2" OD 2 7/8" high 2 3/8" flat</p>	<p>9911 7 1/8" OD 3 5/8" high 2 3/4" flat</p>
---	---	---



All three available
 with bottom turned in
 (mushroom shape)
 as shown on 7912,
 PNS 6912, 7912, 9912



Inside view-
 shown no
 center hole

TRACK LITES / DOWN LITES



304-524
 3 13/32" ID
 3 3/4" high

Available tapped, vented,
 and/or
 with side holes

304 can be
 mated with any pan



Shown in polished brass

304-528-R-V
 3 11/32" ID
 5 7/16" high
 Standard with
 inside rolled edge
 Shown vented

Available without vents
 and/or with side holes

*304 can also be
 mated with
 612 half ball with
 inside rolled edge*



Shown in polished brass

304-611-TV
 4 1/4" ID
 5 1/8" high

Shown
 tapped & vented

Available without
 tapped or vent holes
 and/or with side holes

CEILING COLLARS

7323
5 1/4" OD
3 3/8" ID
1 1/2" high
3 1/4" glassholder



7324
5 1/4" OD
4 1/16" ID
1 1/2" high
4" glassholder



7323 - 7324
Standard tapped, with 2 or 4 key holes and snap-in socket hole

PORCH LAMP

1010
Standard tapped
with hangar bar holes

Socket is approved for
wet location

Available in painted or
plated finishes



PIN-UP LIGHT

201-614
Standard with
hangar bar holes,
available with switch hole

Available in painted or
plated finishes

Socket is not provided



SQUARE / RECTANGULAR WALL BACKS

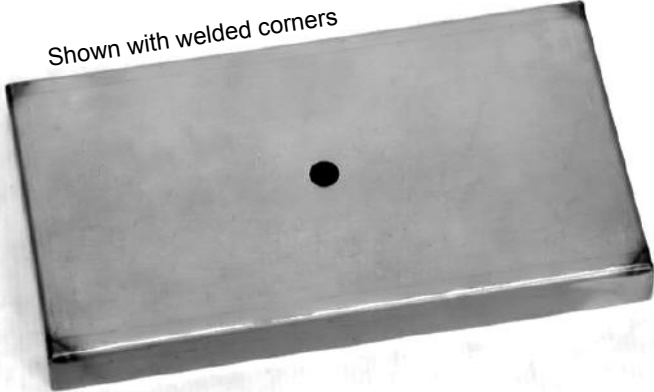

Shown with welded corners

R4510



Shown with 2L hole pattern

R456 4 1/2" X 6" X 3/4"
 R458 4 1/2" X 8" X 3/4"
 R4510 4 1/2" X 10" X 3/4"
 R4512 4 1/2" X 12" X 3/4"



Shown with welded corners

Standard in 20ga, available in 18ga.
 Available with or without welded corners
 Specify hole pattern (center hole only, 2L, hangar holes, no center hole, or other)

Custom square or rectangular backplates and lamp bases available upon order. Specify size (width, length, height) along with material type or finish, hole pattern, with or without welded corners, and without or without turned in edge (flange) for felt.



Drawn Rectangular Pan



R810-22
 5 1/8" X 6 5/16" OD
 1 1/4" high
 Standard with
 no center hole
 uneven lip around pan



Drawn Square Back

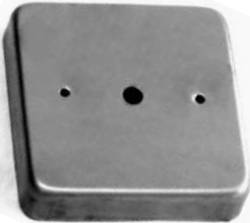

Shown with hangar holes

740	4 1/2" square X 1 1/2" high	standard 24ga
741	4 1/2" square X 15/16" high	standard 20ga
741-5/8	4 1/2" square X 5/8" high	standard 20ga

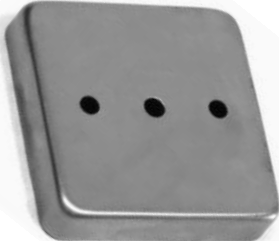

Shown with 2L hole pattern

Standard with .406 center hole to slip 1/8 pipe
 Specify additional holes and/or order without center hole

SWITCH PLATES



Double Switch Plate

Double plates are
4 5/8" X 4 5/8" OD

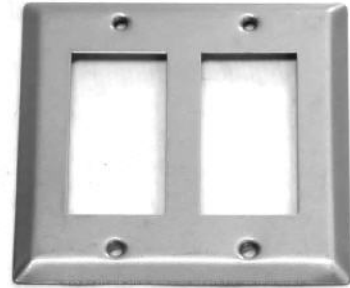

Double Rocker Plate



Single Switch Plate

Switch plates available in raw steel,
stainless steel, raw brass, raw copper and
with powdercoated or plated finishes.



Single Outlet Plate

Single plates are
2 7/8" X 4 5/8" OD



Single Rocker Plate

DECORATIVE BRACKET ASSEMBLY



230

2 1/4" ID - 2" high

15A13

15B13

6 1/4" long X 2" wide

MISCELLANEOUS BRACKETS

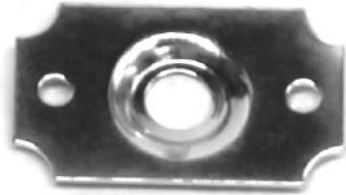

251-CB
 2" long X 1 1/4" wide
 .406 extruded center hole
 two 3/16" holes - 1 1/2" CC

SR-1

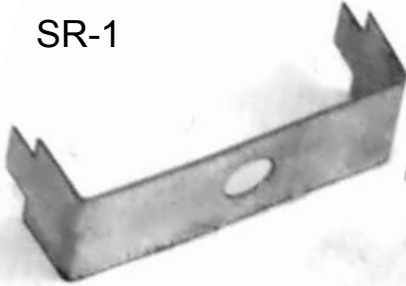

SR 1-1/4



SR-1 - 1" wide
SR-1 1/4 - 1 1/4" wide
 2 5/8" long X 1" deep
 Standard with .7/16" center hole
 Standard in 24ga galvanized steel

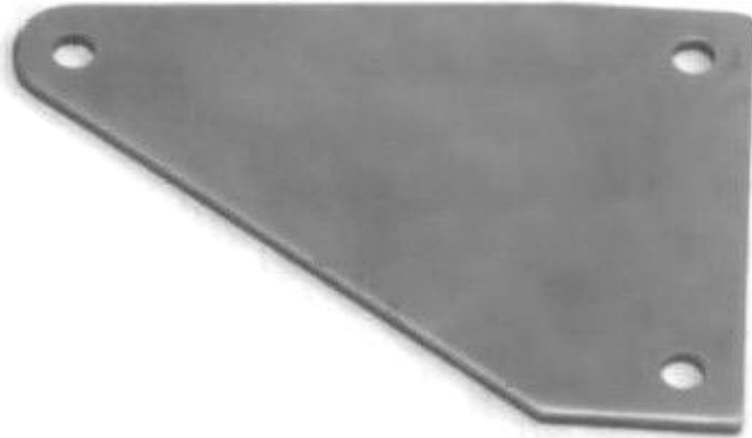
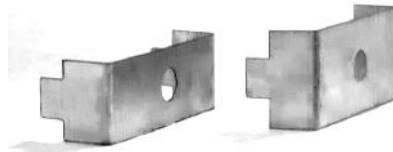

Tri-Bracket
 4 11/16" long
 3 1/4" wide
 3 - 5/16" holes
 11 ga



Door or Gate
Double Latch Bracket
 6 5/8" X 1"
 Standard 14 ga CRS



CANDLE CUPS & CAPS

A231-A23C
 1 11/16" ID
 1 1/2" high
 Straight cup,
 embossed bottom
 Standard in aluminum



A23-A23C
 1 11/16" ID
 1 1/2" high
 Decorative rib along top
 Recessed bottom
 Available with stamp on bottom
 "Made in USA"
 "100% recyclable"
 Standard in aluminum



custom caps shown

5121-512C
 3 5/16" ID
 2" high
 Straight cup, rounded bottom
 Standard in aluminum
 Custom stamp available on cap



512-512C
 3 5/16" ID
 2 3/16" high
 Decorative rib along top
 Embossed bottom
 Custom stamp available
 on cap and/or bottom
 Standard in aluminum



Shown with custom cap

Custom stamp shown



Additional samples of
 custom caps

BANDED AND SPOTWELDED CANDLE CUPS



1811-445 CAS



A60-PE69



522-P30



801-P53



770-PE97

Choose the cup, pan, or part of your choice to be banded with the banding of your choice

SAMPLES OF PARTS USED AS ACCESSORIES & DECORATIVE ITEMS



Shown with candle

"Flower Pot" candle cup
556-556C

556C
3 9/16" ID
1/2" high



Standard 16ga
aluminum



556
3 9/16" OD
2 1/8" high



Whimsical Flower Pot Design
Made from
4021 bobèche with felt center
"S" vine
2 #3178 leaves
529 cup

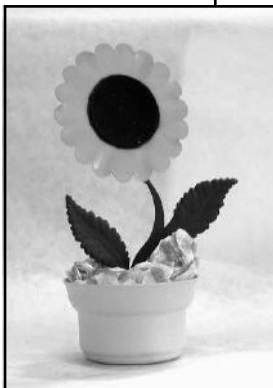

Q49

Vase Caps
used on
candy dishes,
strawholders,
and etc.



476

SAMPLES OF VARIOUS HOLE PATTERNS



488-4SL



415-Fan body
2 key holes & offset hole on top
4SL-switch hole on side



302-T

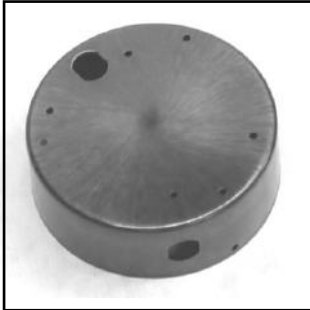

603-Custom

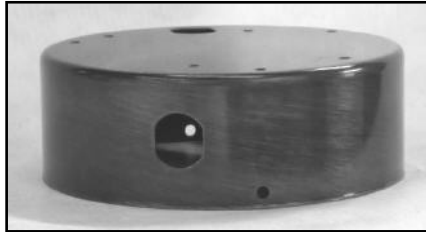

307-3key



650.5-18-T



304-SL



A21-7/8"CH



A62-3BL-3BL-6SL
Triangle pattern &
6 side holes



330-5SL-5SL
5 double
side hole pattern

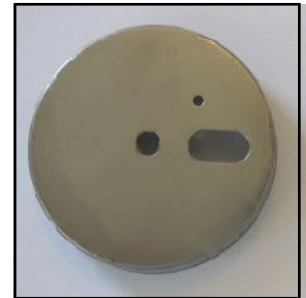

776-Custom



A62-6BL-6BL
double triangle pattern



516-8BL

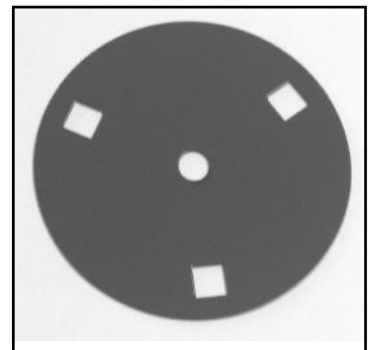

779-3SQBL

SAMPLES OF CUSTOM & CUSTOMER OWNED PARTS

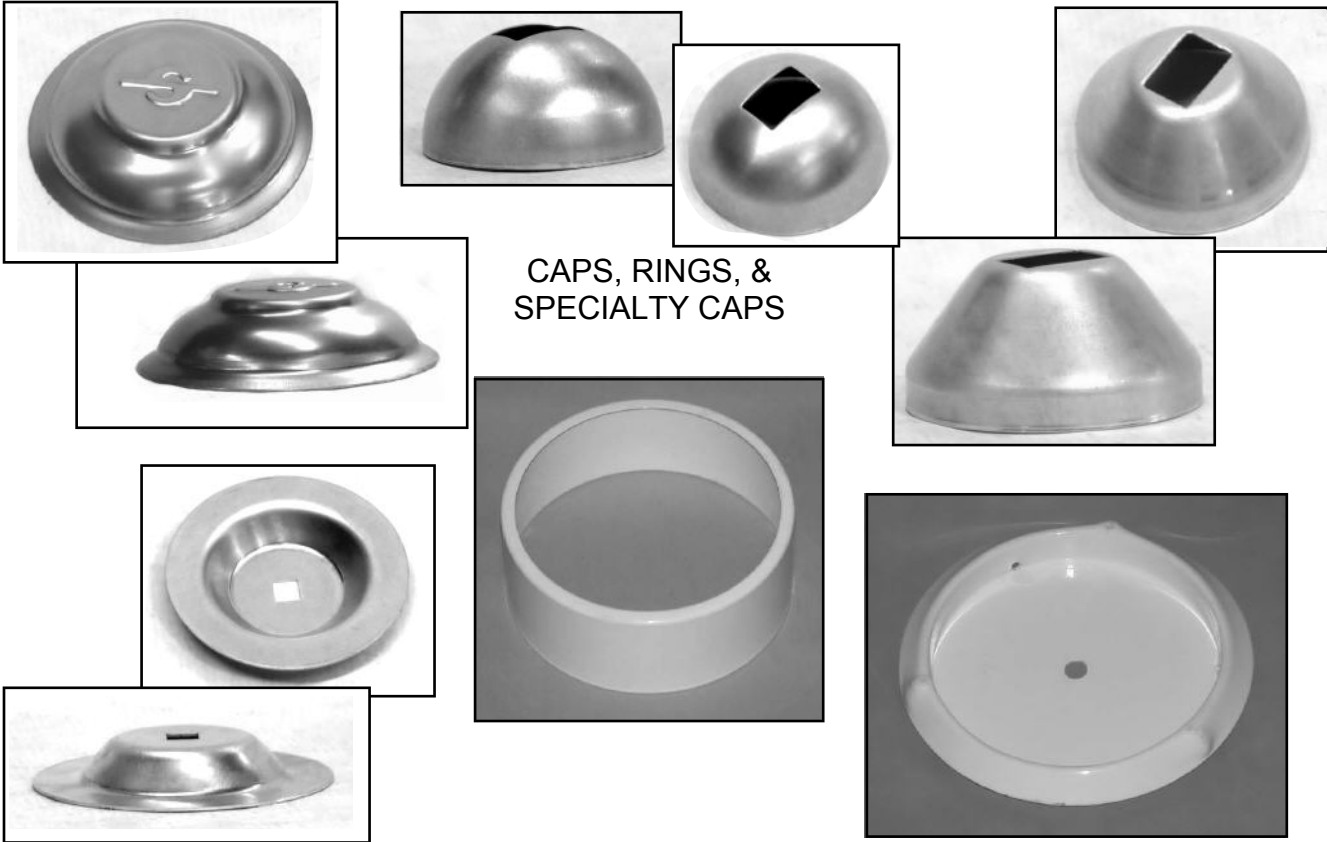

CUSTOM & CUSTOMER OWNED PARTS BUILT TO PRINT OR SAMPLE

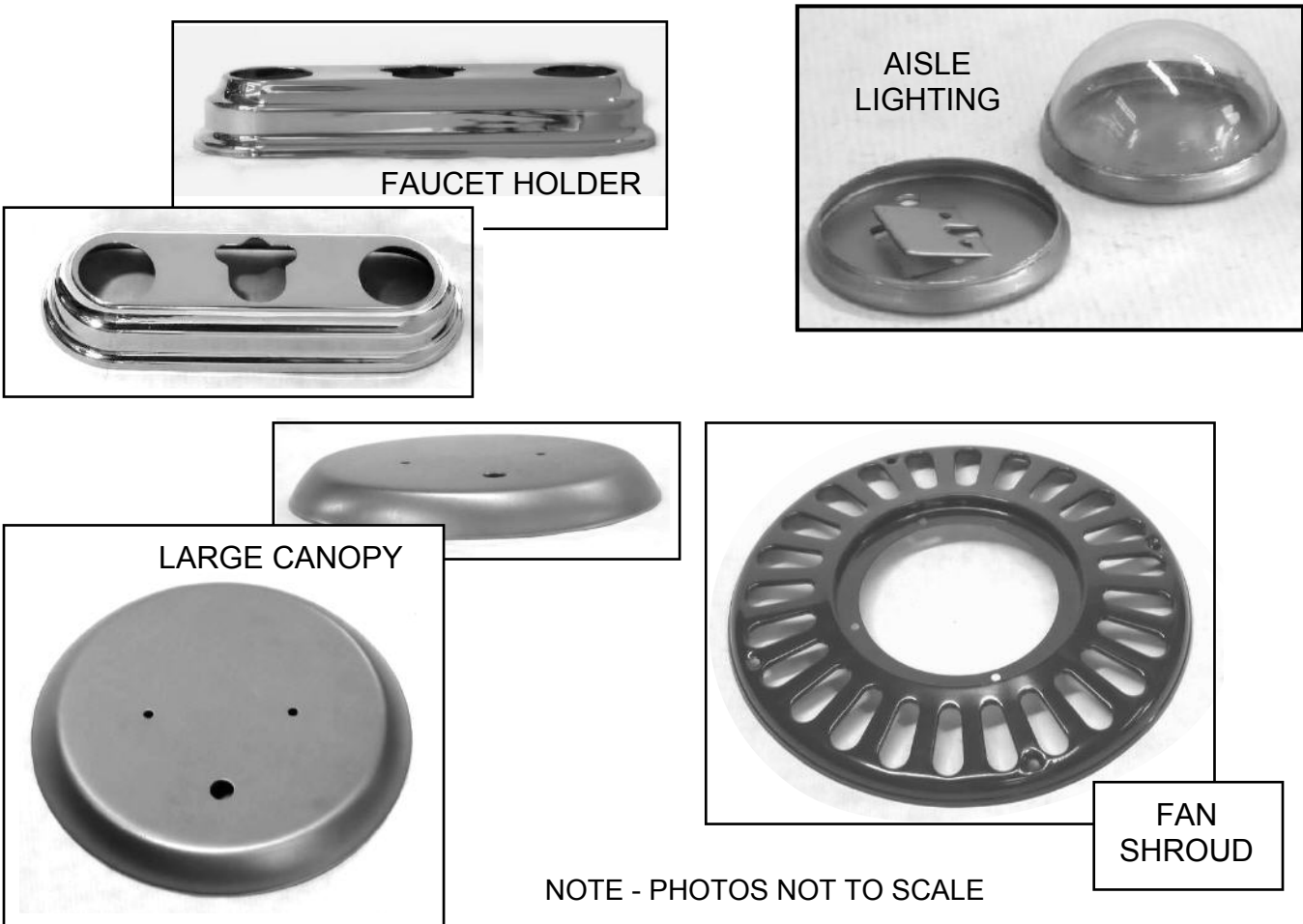

INDEX

PART NO.	PAGE NO.	PART NO.	PAGE NO.
0625-20	33	180S-D	55
075	33	181	121
10	114	1811	8,121
1002.16	3,24	1811-212	82,85
1003	37,55,97	1811-445CAS	154
1003-3/4	37,55,97	182	121
100375-NCH-16	32	182-212	82,84
1004	108	183	56
1005	108	184	26,54,56
1010	149	1845	26,54
1027	109	185	56
1050	54,96	1851	56
1065	51	186	56
1079	143	187	56
1101	37,55,97	188	56
1103	109	189	56
1105-11	3,24	190-191	33,82,85
1105D-11	3,24	1901	33
112	71	191	33
112-112	82,84	192	23,27
1149	52	200	69
11491	37,55	200C	30
1179	143	201	58
1200	110	201-614	52,149
1201	37,55	212	71
12005000L	116	212-212	82,84
1200500FL	116	2125	115
1205	3,24,72	220	58
1205-LINER	72	221	59
1216	110	221-D	59
1218	110	222	2,3
1220	37,55,110	230	59,151
1222	37,55,110	230-231	82,85
125-16	32,33	2301	59
1300	111	231	59
1301	55,111	251-CB	152
1303	37,55,110	256X125	144
1316	111	2781	115
15A13	114,151	279	143
15B13	114,151	281	3
150	144	3 1/8"PP	144
162-4	33	3 1/2"PP	144
165	143	301	54
180	26,56	301-1	54
180-1 1/8	54	302	60
1801	54,56	303	54,57
18078	54	304	54,57
180C	30	304-524	148
180C-D	30	304-528-R-V	148
180C-10L	34	304-611-TV	148
180S	30,55	305	54,57

INDEX

PART NO.	PAGE NO.	PART NO.	PAGE NO.
307	59	408S-541S	82
310	69	409	9,32
310-T	69	410	3
310-V	69	411	71
311	60	412	71
312	60	412-413	71,82,86
313	71	412-4132	71.82.85
313-314	71,82,86	4122	71
313-3142	71,82,85	4125	62
314	71	413	71
3141	71	414	26
3142	71	415	29
316	60	416	31
3178	115	420	61
320	120,121	421	3
320-313	82	422	3
320-358	82	4225	115
322	3	4225S	115
325	143	425	3
330	26	431	120,124
331	27	439	57
345	61	4391	55
350	26	440	9
350C	30	441	54
350C-NCH-16	32	441S	54
351	61	442	54
352	4,8	442-CAS	62
354	31	443	54
358	60	445	54
358-314	82	445-CAS	62
364	122	447	54
364-313	82,85	458	62
365	143	459	27
3669	120,122	460	4,11
36691	120,122	464	10,124
3669-358	82	464-412	82,85
381	3	468	9,124
3992	54,57	476	122
3993	56	478	143
4" PP	144	479	143
4001	6,9,114	480	10,124
4001WRA-V-20	118	481	2,3,72
401	6,11	482	123
401-84	80	482-458	82
402	6,13	482-483	82,87,140
4021	7,16	483	10,123
403	69	483-485	82,87
404-22	4,9	483-48511	82,87
405	55	484	10,123
408	55	484-413	82,88
408S	55	484-485	82,87

INDEX

PART NO.	PAGE NO.	PART NO.	PAGE NO.
485	10,123	529	66
485-458	82,86	530	128
4851	120,123	530-531	83
48511	123	531	128
48511-5386	82,88	532	126
486	124	534	13,145
487	69	535	120,129
488	27	536	120,130
490	62,120,124	537	63
490-449	82	538	63
490-459	82	5386	120,125
490-48511	82,86	53861	125
500E	70	539	10,63,125
500E-119	80	540	63,125
501	55	5400-20	6,11
502	55	541	55
504	64	541S	55
505	55	5411	125
507	64	542	55
508V	70	543	54
509	11,32,126	544	64
510	64	546	65
510C	30	547	65
510C-D	30	548	66
51021	30	548-100	80
5102C	34	549	62
511	127	552	65
511D	127	556	154
5112	3,12	556C	154
512-512C	153	558	63,125
5121-512C	153	558C-I	30
514	129	558CI-3L-539	82,89
515	29	558CI-3L-540	82,88
516	26	558CI-3L-558	82,88
51678	26	560	12
518	10,98,126	561	3
518-519	82,89,140	5620	114
519	10,126	5622	7,14,117
5192	52	5625	143
520	120,127	564	12,129
520-521	83,89	564-514	83
521	120,127	565	143
5216	145	567	11,126
522	55	567-518	825,89
522-P30	154	568	12,126
523	11,98,126	572	4,13
523-515-FAN	29	575	30
524	55	576	143
526	55,97	580	12,128
527	54	580-581	83,90,140
528	54	581	128

INDEX

PART NO.	PAGE NO.	PART NO.	PAGE NO.
5910	6,8,117	628	14,130
5911	6,13,117	629	120,130
5921	7,13,117	630	120,131
5922	7,13,117	630-6122	83
594	65	630-631	83,89,140
6" PP	144	631	120,131
60 REN	83	631-612	83,91
600E	70	634	131
601	55	6347	15,145
602	67	637	143
602-R	67	638	143
602-100	80	6421	7,118
602-94	80	6422	7,118
603	54	6450	143
603-18	26	6454-20	28,38
604V	70	6454-640-20	83,90
605-T	55	648-18	28,112
606	674	650	26,38
608	67	650-1	26,37,55
608-609	83,90	650-1.125	26
609	67,99	650-.5	26,37,55
610	70,99	650-.75	26,37,55
611	68	650-.8	26
6115	115	650-.825	37,55
612	71	650C	30,55
612-613	71,83,86	6500	143
612-6122	71,83,85	6515	5,22
6122	71	6515D	5,22
613	71	65151	22,146
614	38	6578	5,21
615	68	674-22	4,17
615-R-CAS	68	675	38
616	15,99,118	678	143
617	15,99,118	680	4,16,68
618	131	681	17,145
618-6122	83	6911	147
618-619	83	6912	147
619	131	698	99
620	3	699	100
621	3,72	700E	43
622	3	700275L	116
623	31	701	43
624	30	701-712	83
625	14	702	44
6250	3	702-712	83
626	37,55	704	39,133
626D	37,55	705	3,39,72
626S	37,55	7052	3,19
626-T	55	7053	3,19
627	37,55	7058-18	5,20
627-100	80	707	41

INDEX

PART NO.	PAGE NO.	PART NO.	PAGE NO.
707-711	83,92	760	46,91,120,137
708-20	18	761	145
709	18,39,133	764	41,100
709-7092	83,92	765	143
7092	133	770	37,55,97
7092-718	83,92	770-PE97	154
710	44	770-3/4	37,55,97
710-712	83	7705	26
711	44	7705-24	54,97
712	71	772	26
7125	43	772-1 1/8	26
714	39,133	772-1 3/8	26
7141-1.06CH	39	774	100
7142	3,19	775	32
715	30,37,39	7756	32
716	20,136	7758	32
717	41,135	776	37,55
718	18,40,134	777	100
719	40,134	778	100
720	45	779	143
725	41	780	42,98,135
729	38,120,135	781	72
729-709	83	790	46,100
729-734	83,89	7900	54
7292	132	791	54,97
730	45,120,135	7911	147
730-712	83,91	7912	147
7323	149	7912-V-1SL	145
7324	149	7915	54,96,97
734	40,120,134	792	26
734-718	83,93	794	40,132
739-1.328CH	42	794-7092	83,91
740	51,55,150	795	38
741	51,55,150	796	100
741-5/8	51,55,150	7964	100
7433	143	797	101
745	143	7972	26
746	72	7973	47,101
750	45,98,136	7974	47,101
750-712	83,94	798	101
7514-1.406CH	42	799	101
754C	30	800	102
7541	3,20	800125L	115
7545	3,20,72	8005	54,96
755	46,136	801	37,55
755-712	83,94	801-P53	154
759	17,132	801C	30
759-709	83,93	801S	30
759-718	83	802	3,24,47,72
759-7592	83,91	804	48,137
7592	132	804-805	83

INDEX

PART NO.	PAGE NO.	PART NO.	PAGE NO.
805	48,138	9515-22	5,23
806	48,138	958-22	22
807	37,55,97	959	23
807-18	26	979	143
807-3/4	37,55,97	9812	146
808-18	21	9911	147
810	102	9912	147
811	102,112	997	108
816	147	998	146
8161	146		
824	102	A10C	30
8241	102	A11	8,121
825	102	A11-112	82,84
8251	102	A17	33
830	98,120,139	A18	58
830D	139	A181	58
845-20	50	A19	58
850	49,137	E-100	78
854	50	E-101	78
855	50	E-102	78
855FP	50	E-103	78
861	146	P-1	74
867	49,103,139	P-10	74
8688	143	P-12	74
875	32	P-13	74
879	143	P-14	74
890	103	P-15	74
892	103	P-1562	79
894	103	P-16	74
897	104	P-18	74
8975	28,104	P-19	74
898	37,55,97	P-119	78
898-3/4	37,55,97	P-S100	79
898S	37,55	PE-100	78
8985	54,96	S100	33
899	104	S125	33
900	105	S158	33
903	37,55,97	A20	585
904	105	A20C	30
905	105	A20C-D	30
910	106	A20C-TI-112	82,84
9104	146	A20R	58
912	37,55	A21	8,121
920	96,97	A21-A22	82,84,140
921	106	A22	1421
922	37,55,97	A22-A18	82,84
925	37,55,97	A23-A23C	153
926	107	A24	58
941	107	IVY2	114
942	107	IVY25	114
950	54.,96	P-2	74

INDEX

PART NO.	PAGE NO.	PART NO.	PAGE NO.
P-20	74	408S-541S	82
P-21	74	409	9,32
P-22	74	410	3
P-23	74	411	71
P-24	75	412	71
P-25	75	412-413	71,82,86
P-28	75	412-4132	71.82.85
A30	26	4122	71
A30C	30	4125	62
A30C-D	30	413	71
A30C-NCH-18	32	414	26
A3078	26	415	29
A31	8,121	416	31
A31-A32	82,85	420	61
A31-358	82	421	3
A31-313	82	422	3
A32	121	4225	115
A32-314	82	4225S	115
A33	4,8,121	425	3
A35	4	431	120,124
A36	31	439	57
A37	29	4391	55
E-31	75	440	9
E-32	75	441	54
E-33	75	441S	54
P-3	74	442	54
P-30	75	442-CAS	62
P-39	75	443	54
P-S375	79	445	54
PE-35	75	445-CAS	62
PE-36	75	447	54
Q30	55	458	62
A40	122	459	27
A40-A41	82,86	460	4,11
A40C	30	464	10,124
A40C-NCH-16	32	464-412	82,85
A40C-458	82	468	9,124
A41	122	476	122
A42C	30	478	143
A43C	31	479	143
A44	10,98,124	480	10,124
A44-412	82	481	2,3,72
A45C	31	482	123
A46	26	482-458	82
A4658	26	482-483	82,87,140
A4678	26	483	10,123
A47	29	483-485	82,87
A48	26	483-48511	82,87
A48-1	26	484	10,123
A48-1 1/4	26	484-413	82,88
A48C	30	484-485	82,87

INDEX

PART NO.	PAGE NO.	PART NO.	PAGE NO.
A48C-458	82	P-53	76
A49E	69	P-54	79
H40	8,122	P-55	76
H476	120,122	P-56	76
H4761	122	P-S50	79
E-44	75	PE-58	76
E-47	75	PE-59	76
E-48	76	Q52	128
P-4	74	Q56	14,129
P-40	75	A60	54,97
P-41	75	A60-PE69	154
P-42	75	A60C	30
P-49	76	A61	26
PE-43	75	A62	26
PE-44	75	A62-22	97
PE-45	75	A63	26
PE-46	75	A64	37,55
Q40	8	A65	37,55
Q478	9,123	A65-T	55
Q48	54	A65C	31
Q49	9,61,123	A66	37,55
Q49-485	82	A66-18	26
Q49-490	82	A66S-18	26
R4510	150	A67	30,55
R4512	150	A68	28,66
R456	150	A69	26
R458	150	A69-22	54,97
S45	143	A69-3/4	26
A50	26	A69S	26
A50C	30	D610	5,16
A51	12,128	E-60	76
A51-Q52	83	E-61	76
A52	26	E-62	76
A52S	26	E-63	76
A53-22	27	E-64	76
A55C	30	P-6	74
A55C-D	30	P-65	76
A56	55	P-S625	79
A56C	30	PE-60	76
A57-2L	34	PE-61	76
A57-3L	34	PE-62	76
A57-3L-514	83	PE-63	76
A57-3L-518	82	PE-64	76
A57-3L-518D	82	PE-69	77
A58	11	A70C	30
D510	5,16	A79C	30
E-51	76	E-70	77
E-52	76	E-71	77
E-57	76	E-74	77
P-5	74	E-745	77
P-50	76	E-75	77

INDEX

PART NO.	PAGE NO.	PART NO.	PAGE NO.
E-76	77	SR-1	152
P-7	74	SR-1 1/4	152
P-S75	79	Table of Contents	II
ST75-18	33	TRI-BRACKET	152
E-84	77		
E-86	77		
E-87	77		
E-88	77		
E-89	77		
PE-84	77		
PE-86	77		
PE-87	77		
PE-88	77		
PE-89	77		
R810-22	150		
Q801-20	21		
A9C	30		
E-90	77		
E-91	77		
E-92	78		
E-93	78		
E-94	78		
E-95	78		
E-96	78		
E-97	78		
E-98	78		
E-99	78		
P-9	74		
PE-90	77		
PE-91	77		
PE-92	78		
PE-93	78		
PE-94	78		
PE-95	78		
PE-96	78		
PE-97	78		
PE-98	78		
PE-99	78		
AL WASHER	144		
C WASHER	144		
Door Double Latch Brkt	152		
Double Rocker Plate	151		
Double Switch Plate	151		
EARS 638	142		
HEX 416	142		
MG WASHER	144		
RECESSED PARTS	142		
"S" VINE	114		
Single Outlet Plate	151		
Single Rocker Plate	151		

NOTES